

EN

# OWNER'S MANUAL



## Split Air Conditioner ICY Series (With WIFI)



**MODELS:** CH-S09FTXTB-W  
CH-S12FTXTB-W  
CH-S18FTXTB-W  
CH-S24FTXTB-W

For proper operation, please read and keep this manual carefully.

Designed by Cooper&Hunter International Corporation, Oregon, USA  
[www.cooperandhunter.com](http://www.cooperandhunter.com)

# Content

## Operation Notices

Precautions.....	1
Parts Name.....	6

## Screen Operation Guide

Buttons on remote controller.....	7
Introduction for icons on display screen.....	7
Introduction for buttons on remote controller.....	8
Function introduction for combination buttons.....	14
Operation guide.....	16
Replacement of batteries in remote controller.....	16
Emergency operation .....	17

## Maintenance

Clean and Maintenance.....	17
----------------------------	----

## Malfunction

Malfunction analysis .....	20
----------------------------	----

## Installation Notice

Installation dimension diagram .....	24
Tools for installation.....	25
Selection of installation location .....	25
Requirements for electric connection .....	26

## Installation

Installation of indoor unit.....	27
Installation of outdoor unit .....	32
Vacuum pumping.....	35
Leakage detection .....	35
Check after installation .....	36

## Test and operation

Test operation.....	36
---------------------	----

## Attachment

Configuration of connection pipe .....	37
Pipe expanding method.....	39
Wired Controller (Optional) .....	40

This appliance is not intended for use by persons (including children) with reduced physical, sensory or mental capabilities, or lack of experience and knowledge, unless they have been given supervision or instruction concerning use of the appliance by a person responsible for their safety.

Children should be supervised to ensure that they do not play with the appliance.



This marking indicates that this product should not be disposed with other household wastes throughout the EU. To prevent possible harm to the environment or human health from uncontrolled waste disposal, recycle it responsibly to promote the sustainable reuse of material resources. To return your used device, please use the return and collection systems or contact the retailer where the product was purchased. They can take this product for environmental safe recycling.

R410A(R32/125: 50/50): 2087.5

# Explanation of Symbols

---



**DANGER**

Indicates a hazardous situation that, if not avoided, will result in death or serious injury.



**WARNING**

Indicates a hazardous situation that, if not avoided, could result in death or serious injury.



**CAUTION**

Indicates a hazardous situation that, if not avoided, may result in minor or moderate injury.

**NOTICE**

Indicates important but not hazard-related information, used to indicate risk of property damage.



Indicates a hazard that would be assigned a signal word **WARNING** or **CAUTION**.



### WARNING

#### **Operation and Maintenance**

- This appliance can be used by children aged from 8 years and above and persons with reduced physical, sensory or mental capabilities or lack of experience and knowledge if they have been given supervision or instruction concerning use of the appliance in a safe way and understand the hazards involved.
- Children shall not play with the appliance.
- Cleaning and user maintenance shall not be made by children without supervision.
- Do not connect air conditioner to multi-purpose socket. Otherwise, it may cause fire hazard.
- Do disconnect power supply when cleaning air conditioner. Otherwise, it may cause electric shock.
- If the supply cord is damaged, it must be replaced by the manufacturer, its service agent or similarly qualified persons in order to avoid a hazard.
- Do not wash the air conditioner with water to avoid electric shock.
- Do not spray water on indoor unit. It may cause electric shock or malfunction.
- After removing the filter, do not touch fins to avoid injury.
- Do not use fire or hair dryer to dry the filter to avoid deformation or fire hazard.

## Precautions



### WARNING

- Maintenance must be performed by qualified professionals. Otherwise, it may cause personal injury or damage.
- Do not repair air conditioner by yourself. It may cause electric shock or damage. Please contact dealer when you need to repair air conditioner.
- Do not extend fingers or objects into air inlet or air outlet. It may cause personal injury or damage.
- Do not block air outlet or air inlet. It may cause malfunction.
- Do not spill water on the remote controller, otherwise the remote controller may be broken.
- When below phenomenon occurs, please turn off air conditioner and disconnect power immediately, and then contact the dealer or qualified professionals for service.
  - Power cord is overheating or damaged.
  - There's abnormal sound during operation.
  - Circuit break trips off frequently.
  - Air conditioner gives off burning smell.
  - Indoor unit is leaking.
- If the air conditioner operates under abnormal conditions, it may cause malfunction, electric shock or fire hazard.
- When turning on or turning off the unit by emergency operation switch, please press this switch with an insulating object other than metal.
- Do not step on top panel of outdoor unit, or put heavy objects. It may cause damage or personal injury.



### WARNING

#### **Attachment**

- Installation must be performed by qualified professionals. Otherwise, it may cause personal injury or damage.
- Must follow the electric safety regulations when installing the unit.
- According to the local safety regulations, use qualified power supply circuit and circuit break.
- Do install the circuit break. If not, it may cause malfunction.
- An all-pole disconnection switch having a contact separation of at least 3mm in all poles should be connected in fixed wiring.
- Including an circuit break with suitable capacity, please note the following table. Air switch should be included magnet buckle and heating buckle function, it can protect the circuit-short and overload.
- Air Conditioner should be properly grounded. Incorrect grounding may cause electric shock.
- Don't use unqualified power cord.
- Make sure the power supply matches with the requirement of air conditioner. Unstable power supply or incorrect wiring or malfunction. Please install proper power supply cables before using the air conditioner.
- Properly connect the live wire, neutral wire and grounding wire of power socket.
- Be sure to cut off the power supply before proceeding any work related to electricity and safety.

## Precautions



### WARNING

- Do not put through the power before finishing installation.
- If the supply cord is damaged, it must be replaced by the manufacturer, its service agent or similarly qualified persons in order to avoid a hazard.
- The temperature of refrigerant circuit will be high, please keep the interconnection cable away from the copper tube.
- The appliance shall be installed in accordance with national wiring regulations.
- Installation must be performed in accordance with the requirement of NEC and CEC by authorized personnel only.
- The air conditioner is the first class electric appliance. It must be properly grounding with specialized grounding device by a professional. Please make sure it is always grounded effectively, otherwise it may cause electric shock.
- The yellow-green wire in air conditioner is grounding wire, which can't be used for other purposes.
- The grounding resistance should comply with national electric safety regulations.
- The appliance must be positioned so that the plug is accessible.
- All wires of indoor unit and outdoor unit should be connected by a professional.
- If the length of power connection wire is insufficient, please contact the supplier for a new one. Avoid extending the wire by yourself.

## Precautions



### WARNING

- For the air conditioner with plug, the plug should be reachable after finishing installation.
- For the air conditioner without plug, an circuit break must be installed in the line.
- If you need to relocate the air conditioner to another place, only the qualified person can perform the work. Otherwise, it may cause personal injury or damage.
- Select a location which is out of reach for children and far away from animals or plants. If it is unavoidable, please add the fence for safety purpose.
- The indoor unit should be installed close to the wall.
- Instructions for installation and use of this product are provided by the manufacturer.

### Working temperature range

	Indoor side DB/WB(°C )	Outdoor side DB/WB(°C )
Maximum cooling	32/23	43/26
Maximum heating	27/-	24/18

### **NOTICE:**

- The operating temperature range (outdoor temperature) for cooling only unit is  $-15^{\circ}\text{C} \sim 43^{\circ}\text{C}$  ; for heat pump unit is  $-30^{\circ}\text{C} \sim 43^{\circ}\text{C}$  .



# Parts Name

## Indoor Unit

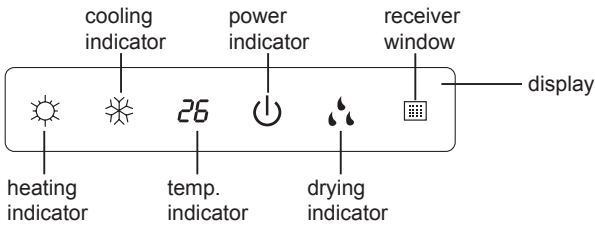
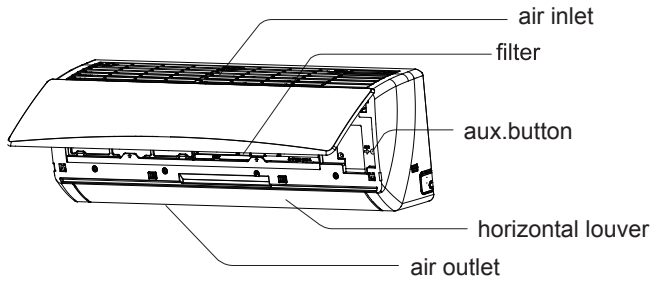

(Display content or position may be different from above graphics, please refer to actual products)



remote control

## Outdoor Unit

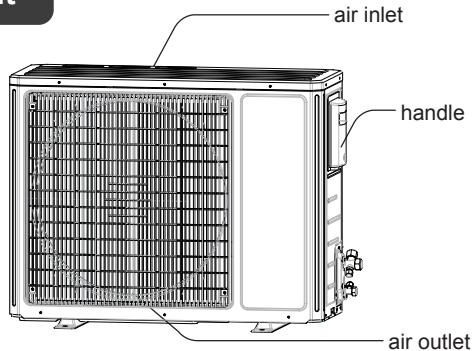

### **NOTICE:**

Actual product may be different from above graphics, please refer to actual products.

# Buttons on remote controller



- 1 ON/OFF button
- 2 MODE button
- 3 FAN button
- 4 TURBO button
- 5 ▲ / ▼ button
- 6 button
- 7 button
- 8 SLEEP button
- 9 I FEEL button
- 10 TIMER ON / TIMER OFF button
- 11 CLOCK button
- 12 QUIET button
- 13 X-FAN button  
(Note: X-FAN is the same with BLOW.)
- 14 LIGHT button
- 15 button
- 16 TEMP button

# Introduction for icons on display screen

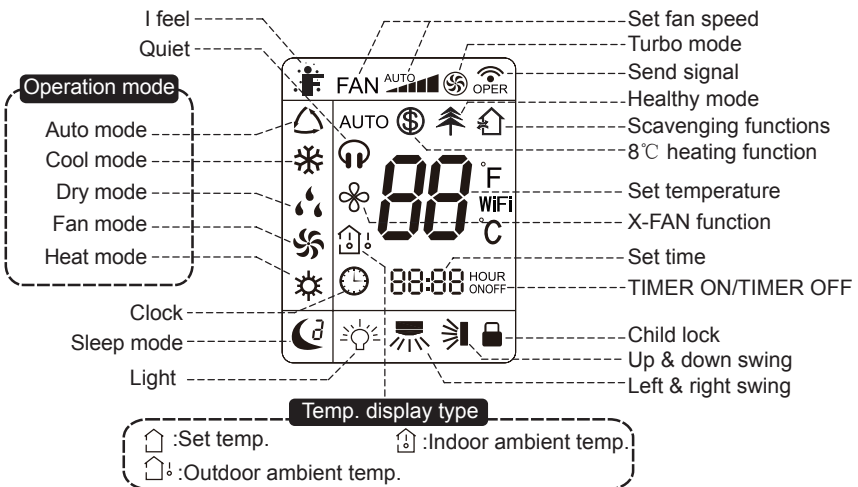

# Introduction for buttons on remote controller

## Note:

- This is a general use remote controller, it could be used for the air conditioners with multifunction; For some function, which the model doesn't have, if press the corresponding button on the remote controller that the unit will keep the original running status.
- After putting through the power, the air conditioner will give out a sound. Operation indicator "⏻" is ON (red indicator). After that, you can operate the air conditioner by using remote controller.
- Under on status, pressing the button on the remote controller, the signal icon "📶" on the display of remote controller will blink once and the air conditioner will give out a "de" sound, which means the signal has been sent to the air conditioner.

## 1 ON/OFF button

Press this button can turn on or turn off the air conditioner. After turning on the air conditioner, operation indicator "⏻" on indoor unit's display is ON (green indicator. The colour is different for different models), and indoor unit will give out a sound.

## 2 MODE button

Press this button to select your required operation mode.





- When selecting auto mode, air conditioner will operate automatically according to the sensed temperature. Set temperature can't be adjusted and will not be displayed as well. Press "FAN" button can adjust fan speed. Press "📶" / "📶" button can adjust fan blowing angle.
- After selecting cool mode, air conditioner will operate under cool mode. Cool indicator "❄️" on indoor unit is ON. Press "▲" or "▼" button to adjust set temperature. Press "FAN" button to adjust fan speed. Press "📶" / "📶" button to adjust fan blowing angle.
- When selecting dry mode, the air conditioner operates at low speed under dry mode. Dry indicator "💧" on indoor unit is ON. Under dry mode, fan speed can't be adjusted. Press "📶" / "📶" button to adjust fan blowing angle.
- When selecting fan mode, the air conditioner will only blow fan, no cooling and no heating. All indicators are OFF, Operation indicator is ON. Press "FAN" button to adjust fan speed. Press "📶" / "📶" button to adjust fan blowing angle.
- When selecting heating mode, the air conditioner operates under heat mode. Heat indicator "☀️" on indoor unit is ON. Press "▲" or "▼" button to adjust set temperature. Press "FAN" button to adjust fan speed. Press "📶" / "📶" button to adjust fan blowing angle. (Cooling only unit won't receive heating mode signal. If setting heat mode with remote controller, press ON/OFF button can't start up the unit).

# Introduction for buttons on remote controller

## Note:

- For preventing cold air, after starting up heating mode, indoor unit will delay 1~5 minutes to blow air (actual delay time is depend on indoor ambient temperature).
- Set temperature range from remote controller: 16~30°C (61~86°F);  
Fan speed: auto, low speed, low-medium speed, medium speed, medium-high speed, high speed.

## 3 FAN button

This button is used for setting Fan Speed in the sequence that goes from AUTO, , ,  to , , then back to Auto.

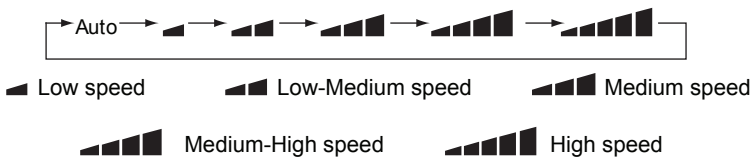

## 4 TURBO button

Under COOL or HEAT mode, press this button to turn to quick COOL or quick HEAT mode. "⚡" icon is displayed on remote controller. Press this button again to exit turbo function and "⚡" icon will disappear.

If start this function, the unit will run at super-high fan speed to cool or heat quickly so that the ambient temp. approaches the preset temp. as soon as possible.

## 5 ▲ / ▼ button

- Press "▲" or "▼" button once increase or decrease set temperature 1°C (°F). Holding "▲" or "▼" button, 2s later, set temperature on remote controller will change quickly. On releasing button after setting is finished, temperature indicator on indoor unit will change accordingly. (Temperature can't be adjusted under auto mode)
- When setting TIMER ON, TIMER OFF or CLOCK, press "▲" or "▼" button to adjust time. (Refer to CLOCK, TIMER ON, TIMER OFF buttons) When setting TIMER ON, TIMER OFF or CLOCK, press "▲" or "▼" button to adjust time. (Refer to CLOCK, TIMER ON, TIMER OFF buttons)

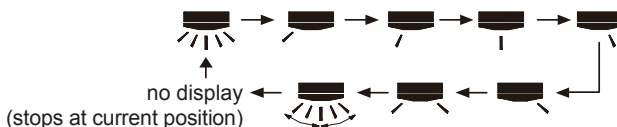

## 6 button

Press this button can select left & right swing angle. Fan blow angle can be selected circularly as below:



# Introduction for buttons on remote controller









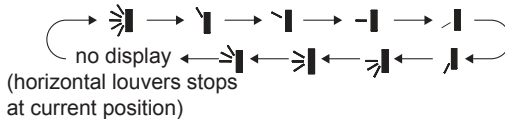

## Note:

- Press this button continuously more than 2s, the main unit will swing back and forth from left to right, and then loosen the button, the unit will stop swinging and present position of guide louver will be kept immediately.
- Under swing left and right mode, when the status is switched from off to , if press this button again 2s later,  status will switch to off status directly; if press this button again within 2s, the change of swing status will also depend on the circulation sequence stated above.





## 7 button

Press this button can select up & down swing angle. Fan blow angle can be selected circularly as below:





- When selecting "  ", air conditioner is blowing fan automatically. Horizontal louver will automatically swing up & down at maximum angle.
- When selecting " , , , ,  ", air conditioner is blowing fan at fixed position. Horizontal louver will stop at the fixed position.
- When selecting " , ,  ", air conditioner is blowing fan at fixed angle. Horizontal louver will send air at the fixed angle.
- Hold "  " button above 2s to set your required swing angle. When reaching your required angle, release the button.

## Note:

- " , ,  " may not be available. When air conditioner receives this signal, the air conditioner will blow fan automatically.
- Press this button continuously more than 2s, the main unit will swing back and forth from up to down, and then loosen the button, the unit will stop swinging and present position of guide louver will be kept immediately.
- Under swing up and down mode, when the status is switched from off to , if press this button again 2s later,  status will switch to off status directly; if press this button again within 2s, the change of swing status will also depend on the circulation sequence stated above.

## 8 SLEEP button

- Press this button, can select Sleep 1 (  ), Sleep 2 (  ), Sleep 3 (  ) and cancel the Sleep, circulate between these, after electrified, Sleep Cancel is defaulted. Sleep 1 is Sleep mode 1, in Cool modes; sleep status after run for one hour, the

# Introduction for buttons on remote controller

main unit setting temperature will increase 1°C, two hours, setting temperature increased 2°C, then the unit will run at this setting temperature; In Heat mode: sleep status after run for one hour, the setting temperature will decrease 1°C, two hours, setting temperature will decrease 2°C, then the unit will run at this setting temperature.

- Sleep 2 is sleep mode 2, that is air conditioner will run according to the presetting a group of sleep temperature curve.

- Sleep 3-the sleep curve setting under Sleep mode by DIY;

(1) Under Sleep 3 mode, press "Turbo" button for a long time, remote controller enters into user individuation sleep setting status, at this time, the time of remote controller will display "1hour", the setting temperature "88" will display the corresponding temperature of last setting sleep curve and blink (The first entering will display according to the initial curve setting value of original factory);

(2) Adjust "+" and "-" button, could change the corresponding setting temperature, after adjusted, press "Turbo" button for confirmation;

(3) At this time, 1hour will be automatically increased at the timer position on the remote control, (that are "2hours" or "3hours" or "8hours"), the place of setting temperature "88" will display the corresponding temperature of last setting sleep curve and blink;

(4) Repeat the above step (2)~(3) operation, until 8 hours temperature setting finished, sleep, curve setting finished, at this time, the remote controller will resume the original timer display; temperature display will resume to original setting temperature.

- Sleep3- the sleep curve setting under Sleep mode by DIY could be inquired:

The user could accord to sleep curve setting method to inquire the presetting sleep curve, enter into user individuation sleep setting status, but do not change the temperature, press "Turbo" button directly for confirmation. Note: In the above presetting or enquiry procedure, if continuously within 10s, there is no button pressed, the sleep curve setting within 10s, there is no button pressed, the sleep curve setting status will be automatically quit and resume to display the original displaying. In the presetting or enquiry procedure, press "ON/OFF" button, "Mode" button, "Timer" button or "Sleep" button, the sleep curve setting or enquiry status will quit similarly.

## 9 I FEEL button

Press this button to start I FEEL function and "⊞" will be displayed on the remote controller. After this function is set, the remote controller will send the detected ambient temperature to the controller and the unit will automatically adjust the indoor temperature according to the detected temperature. Press this button again to close I FEEL function and "⊞" will disappear.

- Please put the remote controller near user when this function is set. Do not put

# Introduction for buttons on remote controller

the remote controller near the object of high temperature or low temperature in order to avoid detecting inaccurate ambient temperature.

## 10 TIMER ON / TIMER OFF button

### • TIMER ON button

"TIMER ON" button can set the time for timer on. After pressing this button, "🕒" icon disappears and the word "ON" on remote controller blinks. Press "▲" or "▼" button to adjust TIMER ON setting. After each pressing "▲" or "▼" button, TIMER ON setting will increase or decrease 1min. Hold "▲" or "▼" button, 2s later, the time will change quickly until reaching your required time.

Press "TIMER ON" to confirm it. The word "ON" will stop blinking. "🕒" icon resumes displaying. Cancel TIMER ON: Under the condition that TIMER ON is started up, press "TIMER ON" button to cancel it.

### • TIMER OFF button

"TIMER OFF" button can set the time for timer off. After pressing this button, "🕒" icon disappears and the word "OFF" on remote controller blinks. Press "▲" or "▼" button to adjust TIMER OFF setting. After each pressing "▲" or "▼" button, TIMER OFF setting will increase or decrease 1min. Hold "▲" or "▼" button, 2s later, the time will change quickly until reaching your required time.

Press "TIMER OFF" word "OFF" will stop blinking. "🕒" icon resumes displaying. Cancel TIMER OFF. Under the condition that TIMER OFF is started up, press "TIMER OFF" button to cancel it.

## Note:

- Under on and off status, you can set TIMER OFF or TIMER ON simultaneously.
- Before setting TIMER ON or TIMER OFF, please adjust the clock time.
- After starting up TIMER ON or TIMER OFF, set the constant circulating valid. After that, air conditioner will be turned on or turned off according to setting time. ON/OFF button has no effect on setting. If you don't need this function, please use remote controller to cancel it.

## 11 CLOCK button



Press this button to set clock time. "🕒" icon on remote controller will blink. Press "▲" or "▼" button within 5s to set clock time. Each pressing of "▲" or "▼" button, clock time will increase or decrease 1 minute. If hold "▲" or "▼" button, 2s later, time will change quickly. Release this button when reaching your required time. Press "CLOCK" button to confirm the time. "🕒" icon stops blinking.

## Note:

- Clock time adopts 24-hour mode.
- The interval between two operation can't exceeds 5s. Otherwise, remote controller will quit setting status. Operation for TIMER ON/TIMER OFF is the same.

# Introduction for buttons on remote controller

## 12 QUIET button

Press this button, the Quiet status is under the Auto Quiet mode (display "") and "AUTO" signal ) and Quiet mode (display "" signal) and Quiet OFF (there is no signal of "" displayed), after powered on, the Quiet OFF is defaulted.

### Note:

- The Quiet function can be set up in all modes; Under the Quiet mode, the fan speed is not available.
- When quiet function is selected:
  - Under cooling mode: indoor fan operates at notch 4 speed. 10 minutes later or when indoor ambient temperature  $\leq 28^{\circ}\text{C}$ , indoor fan will operate at notch 2 speed or quiet mode according to the comparison between indoor ambient temperature and set temperature.
  - Under heating mode: indoor fan operates at notch 3 speed or quiet mode according to the comparison between indoor ambient temperature and set temperature.
  - Under dry, fan mode: indoor fan operates at quiet mode.
  - Under auto mode: the indoor fan operates at the auto quiet mode according to actual cooling, heating or fan mode.
- The Quiet function is only available for some models.



## 13 X-FAN button

Pressing this button in COOL or DRY mode, the icon "" is displayed and the indoor fan will continue operation for 2 minutes in order to dry the indoor unit even though you have turned off the unit. After energization, X-FAN OFF is defaulted. X-FAN is not available in AUTO, FAN or HEAT mode.

This function indicates that moisture on evaporator of indoor unit will be blown after the unit is stopped to avoid mould.

- Having set X-FAN function on: After turning off the unit by pressing ON/OFF button indoor fan will continue running for about 2 min. at low speed. In this period, press X-FAN button to stop indoor fan directly.
- Having set X-FAN function off: After turning off the unit by pressing ON/OFF button, the complete unit will be off directly.

## 14 LIGHT button

Press this button to turn off display light on indoor unit. "" icon on remote controller disappears. Press this button again to turn on display light. "" icon is displayed.

## 15 button

Press this button to achieve the on and off of healthy and scavenging functions in operation status. Press this button for the first time to start scavenging function;



# Function introduction for combination buttons

LCD displays "🏠". Press the button for the second time to start healthy and scavenging functions simultaneously; LCD displays "🏠" and "🌿". Press this button for the third time to quit healthy and scavenging functions simultaneously. Press the button for the fourth time to start healthy function; LCD display "🌿". Press this button again to repeat the operation above.

- This function is applicable to partial of models.

## 16 TEMP button

By pressing this button, you can see indoor set temperature, indoor ambient temperature or outdoor ambient temperature on indoor unit's display. The setting on remote controller is selected circularly as below:

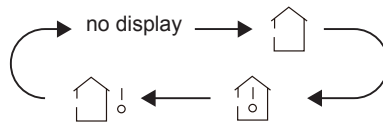

- When selecting "🏠" or no display with remote controller, temperature indicator on indoor unit displays set temperature.
- When selecting "🏠☀️" with remote controller, temperature indicator on indoor unit displays indoor ambient temperature.
- When selecting "🏠☀️☁️" with remote controller, temperature indicator on indoor unit displays outdoor ambient temperature.

### Note:

- Outdoor temperature display is not available for some models. At that time, indoor unit receives "🏠☀️" signal, while it displays indoor set temperature.
- It's defaulted to display set temperature when turning on the unit. There is no display in the remote controller.
- Only for the models whose indoor unit has dual-8 display.
- When selecting displaying of indoor or outdoor ambient temperature, indoor temperature indicator displays corresponding temperature and automatically turn to display set temperature after three or five seconds.

## Energy-saving function

Under cooling mode, press "TEMP" and "CLOCK" buttons simultaneously to start up or turn off energy-saving function. When energy-saving function is started up, "SE" will be shown on remote controller, and air conditioner will adjust the set temperature automatically according to ex-factory setting to reach to the best energy-saving effect. Press "TEMP" and "CLOCK" buttons simultaneously again to exit energy-saving function.

### Note:

- Under energy-saving function, fan speed is defaulted at auto speed and it can't be adjusted.

# Function introduction for combination buttons

- Under energy-saving function, set temperature can't be adjusted. Press "TURBO" button and the remote controller won't send signal.
- Sleep function and energy-saving function can't operate at the same time. If energy-saving function has been set under cooling mode, press sleep button will cancel energy-saving function. If sleep function has been set under cooling mode, start up the energy-saving function will cancel sleep function.

## 8°C heating function

Under heating mode, press "TEMP" and "CLOCK" buttons simultaneously to start up or turn off 8°C heating function. When this function is started up, "Ⓢ" and "8°C" will be shown on remote controller, and the air conditioner keep the heating status at 8°C. Press "TEMP" and "CLOCK" buttons simultaneously again to exit 8°C heating function.

### Note:

- Under 8°C heating function, fan speed is defaulted at auto speed and it can't be adjusted.
- Under 8°C heating function, set temperature can't be adjusted. Press "TURBO" button and the remote controller won't send signal.
- Sleep function and 8°C heating function can't operate at the same time. If 8°C heating function has been set under cooling mode, press sleep button will cancel 8°C heating function. If sleep function has been set under cooling mode, start up the 8°C heating function will cancel sleep function.
- Under °F temperature display, the remote controller will display 46 °F heating.

## Child lock function

Press "▲" and "▼" simultaneously to turn on or turn off child lock function. When child lock function is on, "🔒" icon is displayed on remote controller. If you operate the remote controller, the "🔒" icon will blink three times without sending signal to the unit.

## Temperature display switchover function

Under OFF status, press "▼" and "MODE" buttons simultaneously to switch temperature display between °C and °F.

## WiFi Function

Press "MODE" and "TURBO" button simultaneously to turn on or turn off WiFi function. When WiFi function is turned on, the "WiFi" icon will be displayed on remote controller; Long press "MODE" and "TURBO" buttons simultaneously for 10s, remote controller will send WiFi reset code and then the WiFi function will be turned on. WiFi function is defaulted ON after energization of the remote controller.

## Operation guide

1. After putting through the power, press "ON/OFF" button on remote controller to turn on the air conditioner.
2. Press "MODE" button to select your required mode: AUTO, COOL, DRY, FAN, HEAT.
3. Press "▲" or "▼" button to set your required temperature. (Temperature can't be adjusted under auto mode).
4. Press "FAN" button to set your required fan speed: auto, low speed, low-medium speed, medium speed, medium-high speed, high speed.
5. Press "↻" button to select fan blowing angle.

## Replacement of batteries in remote controller

1. Press the back side of remote controller marked with "OPEN", as shown in the fig, and then push out the cover of battery box along the arrow direction.
2. Replace two 7# (AAA 1.5V) dry batteries, and make sure the position of "+" polar and "-" polar are correct.
3. Reinstall the cover of battery box.

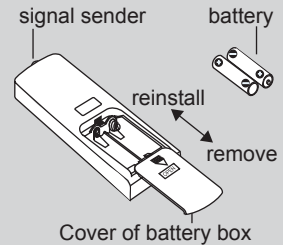

### NOTICE

- During operation, point the remote control signal sender at the receiving window on indoor unit.
- The distance between signal sender and receiving window should be no more than 8m, and there should be no obstacles between them.
- Signal may be interfered easily in the room where there is fluorescent lamp or wireless telephone; remote controller should be close to indoor unit during operation.
- Replace new batteries of the same model when replacement is required.
- When you don't use remote controller for a long time, please take out the batteries.
- If the display on remote controller is fuzzy or there's no display, please replace batteries.

## Emergency operation

If remote controller is lost or damaged, please use auxiliary button to turn on or turn off the air conditioner. The operation in details are as below: As shown in the fig. Open panel, press aux. button to turn on or turn off the air conditioner. When the air conditioner is turned on, it will operate under auto mode.

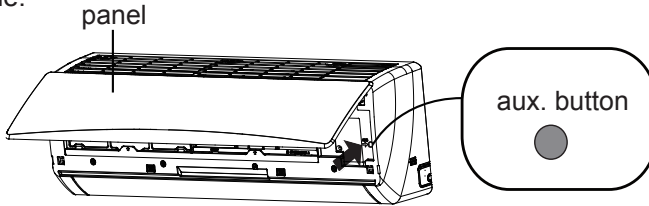

### **WARNING:**

Use insulated object to press the auto button

## Clean and Maintenance



### **WARNING**

- Turn off the air conditioner and disconnect the power before cleaning the air conditioner to avoid electric shock.
- Do not wash the air conditioner with water to avoid electric shock.
- Do not use volatile liquid to clean the air conditioner.

### **Clean surface of indoor unit**

When the surface of indoor unit is dirty, it is recommended to use a soft dry cloth or wet cloth to wipe it.

### **NOTICE:**

- Do not remove the panel when cleaning it.

# Clean and Maintenance

## Clean filter

### 1 Open panel

Pull out the panel to a certain angle as shown in the fig.

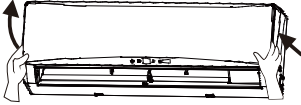

### 2 Remove filter

Remove the filter as indicated in the fig.

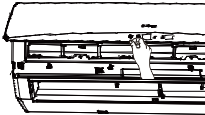

### 3 Clean filter

- Use dust catcher or water to clean the filter.
- When the filter is very dirty, use the water (below 45°C ) to clean it, and then put it in a shady and cool place to dry.

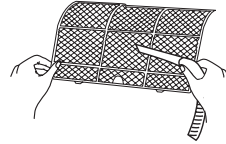

### 4 Install filter

Install the filter and then close the panel cover tightly.

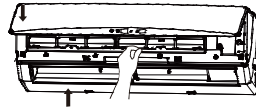

## WARNING

- The filter should be cleaned every three months. If there is much dust in the operation environment, clean frequency can be increased.
- After removing the filter, do not touch fins to avoid injury.
- Do not use fire or hair dryer to dry the filter to avoid deformation or fire hazard.

# Clean and Maintenance

## **NOTICE: Checking before use-season**

1. Check whether air inlets and air outlets are blocked.
2. Check whether air switch, plug and socket are in good condition.
3. Check whether filter is clean.
4. Check whether mounting bracket for outdoor unit is damaged or corroded.  
If yes, please contact dealer.
5. Check whether drainage pipe is damaged.

## **NOTICE: Checking after use-season**

1. Disconnect power supply.
2. Clean filter and indoor unit's panel.
3. Check whether mounting bracket for outdoor unit is damaged or corroded.  
If yes, please contact dealer.

## **Notice for recovery**

1. Many packing materials are recyclable materials.  
Please dispose them in appropriate recycling unit.
2. If you want to dispose the air conditioner, please contact local dealer or consultant service center for the correct disposal method.

# Malfunction analysis

## General phenomenon analysis

Please check below items before asking for maintenance. If the malfunction still can't be eliminated, please contact local dealer or qualified professionals.

Phenomenon	Check items	Solution
Indoor unit can't receive remote controller's signal or remote controller has no action.	<ul style="list-style-type: none"> <li>Whether it's interfered severely (such as static electricity, stable voltage)?</li> </ul>	<ul style="list-style-type: none"> <li>Pull out the plug. Reinsert the plug after about 3min, and then turn on the unit again.</li> </ul>
	<ul style="list-style-type: none"> <li>Whether remote controller is within the signal receiving range?</li> </ul>	<ul style="list-style-type: none"> <li>Signal receiving range is 8m.</li> </ul>
	<ul style="list-style-type: none"> <li>Whether there are obstacles?</li> </ul>	<ul style="list-style-type: none"> <li>Remove obstacles.</li> </ul>
	<ul style="list-style-type: none"> <li>Whether remote controller is pointing at the receiving window?</li> </ul>	<ul style="list-style-type: none"> <li>Select proper angle and point the remote controller at the receiving window on indoor unit.</li> </ul>
	<ul style="list-style-type: none"> <li>Is sensitivity of remote controller low; fuzzy display and no display?</li> </ul>	<ul style="list-style-type: none"> <li>Check the batteries. If the power of batteries is too low, please replace them.</li> </ul>
	<ul style="list-style-type: none"> <li>No display when operating remote controller?</li> </ul>	<ul style="list-style-type: none"> <li>Check whether remote controller appears to be damaged. If yes, replace it.</li> </ul>
	<ul style="list-style-type: none"> <li>Fluorescent lamp in room?</li> </ul>	<ul style="list-style-type: none"> <li>Take the remote controller close to indoor unit.</li> <li>Turn off the fluorescent lamp and then try it again.</li> </ul>
No air emitted from indoor unit	<ul style="list-style-type: none"> <li>Air inlet or air outlet of indoor unit is blocked?</li> </ul>	<ul style="list-style-type: none"> <li>Eliminate obstacles.</li> </ul>
	<ul style="list-style-type: none"> <li>Under heating mode, indoor temperature is reached to set temperature?</li> </ul>	<ul style="list-style-type: none"> <li>After reaching to set temperature, indoor unit will stop blowing out air.</li> </ul>
	<ul style="list-style-type: none"> <li>Heating mode is turned on just now?</li> </ul>	<ul style="list-style-type: none"> <li>In order to prevent blowing out cold air, indoor unit will be started after delaying for several minutes, which is a normal phenomenon.</li> </ul>

# Malfunction analysis

Phenomenon	Check items	Solution
Air conditioner can't operate	● Power failure?	● Wait until power recovery.
	● Is plug loose?	● Reinsert the plug.
	● Air switch trips off or fuse is burnt out?	● Ask professional to replace air switch or fuse.
	● Wiring has malfunction?	● Ask professional to replace it.
	● Unit has restarted immediately after stopping operation?	● Wait for 3min, and then turn on the unit again.
	● Whether the function setting for remote controller is correct?	● Reset the function.
Mist is emitted from indoor unit's air outlet	● Indoor temperature and humidity is high?	● Because indoor air is cooled rapidly. After a while, indoor temperature and humidity will be decrease and mist will disappear.
Set temperature can't be adjusted	● Unit is operating under auto mode?	● Temperature can't be adjusted under auto mode. Please switch the operation mode if you need to adjust temperature.
	● Your required temperature exceeds the set temperature range?	● Set temperature range: 16°C ~30°C .
Cooling (heating) effect is not good.	● Voltage is too low?	● Wait until the voltage resumes normal.
	● Filter is dirty?	● Clean the filter.
	● Set temperature is in proper range?	● Adjust temperature to proper range.
	● Door and window are open?	● Close door and window.



# Malfunction analysis

Phenomenon	Check items	Solution
Odours are emitted	<ul style="list-style-type: none"><li>• Whether there's odour source, such as furniture and cigarette, etc.</li></ul>	<ul style="list-style-type: none"><li>• Eliminate the odour source.</li><li>• Clean the filter.</li></ul>
Air conditioner operates abnormally	<ul style="list-style-type: none"><li>• Whether there's interference, such as thunder, wireless devices, etc.</li></ul>	<ul style="list-style-type: none"><li>• Disconnect power, put back power, and then turn on the unit again.</li></ul>
Outdoor unit has vapor	<ul style="list-style-type: none"><li>• Heating mode is turned on?</li></ul>	<ul style="list-style-type: none"><li>• During defrosting under heating mode, it may generate vapor, which is a normal phenomenon.</li></ul>
"Water flowing" noise	<ul style="list-style-type: none"><li>• Air conditioner is turned on or turned off just now?</li></ul>	<ul style="list-style-type: none"><li>• The noise is the sound of refrigerant flowing inside the unit, which is a normal phenomenon.</li></ul>
Cracking noise	<ul style="list-style-type: none"><li>• Air conditioner is turned on or turned off just now?</li></ul>	<ul style="list-style-type: none"><li>• This is the sound of friction caused by expansion and/or contraction of panel or other parts due to the change of temperature.</li></ul>

# Malfunction analysis

## Error Code

- When air conditioner status is abnormal, temperature indicator on indoor unit will blink to display corresponding error code. Please refer to below list for identification of error code.

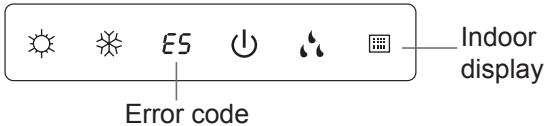

Above indicator diagram is only for reference. Please refer to actual product for the actual indicator and position.

Error code	Troubleshooting
Heating indicator ON 10s OFF 0.5s	Means defrosting status. It's the normal phenomenon.
F1	Please contact qualified professionals for service.
F2	Please contact qualified professionals for service.
C5	Please contact qualified professionals for service.
H6	It can be eliminated after restarting the unit. If not, please contact qualified professionals for service.
JF	Communication malfunction between wifi detection board and main board. When turning off the wifi, this error code won't be displayed.

Note: If there're other error codes, please contact qualified professionals for service.



## WARNING

- When below phenomenon occurs, please turn off air conditioner and disconnect power immediately, and then contact the dealer or qualified professionals for service.
  - Power cord is overheating or damaged.
  - There's abnormal sound during operation.
  - Air switch trips off frequently.
  - Air conditioner gives off burning smell.
  - Indoor unit is leaking.
- Do not repair or refit the air conditioner by yourself.
- If the air conditioner operates under abnormal conditions, it may cause malfunction, electric shock or fire hazard.

# Installation dimension diagram

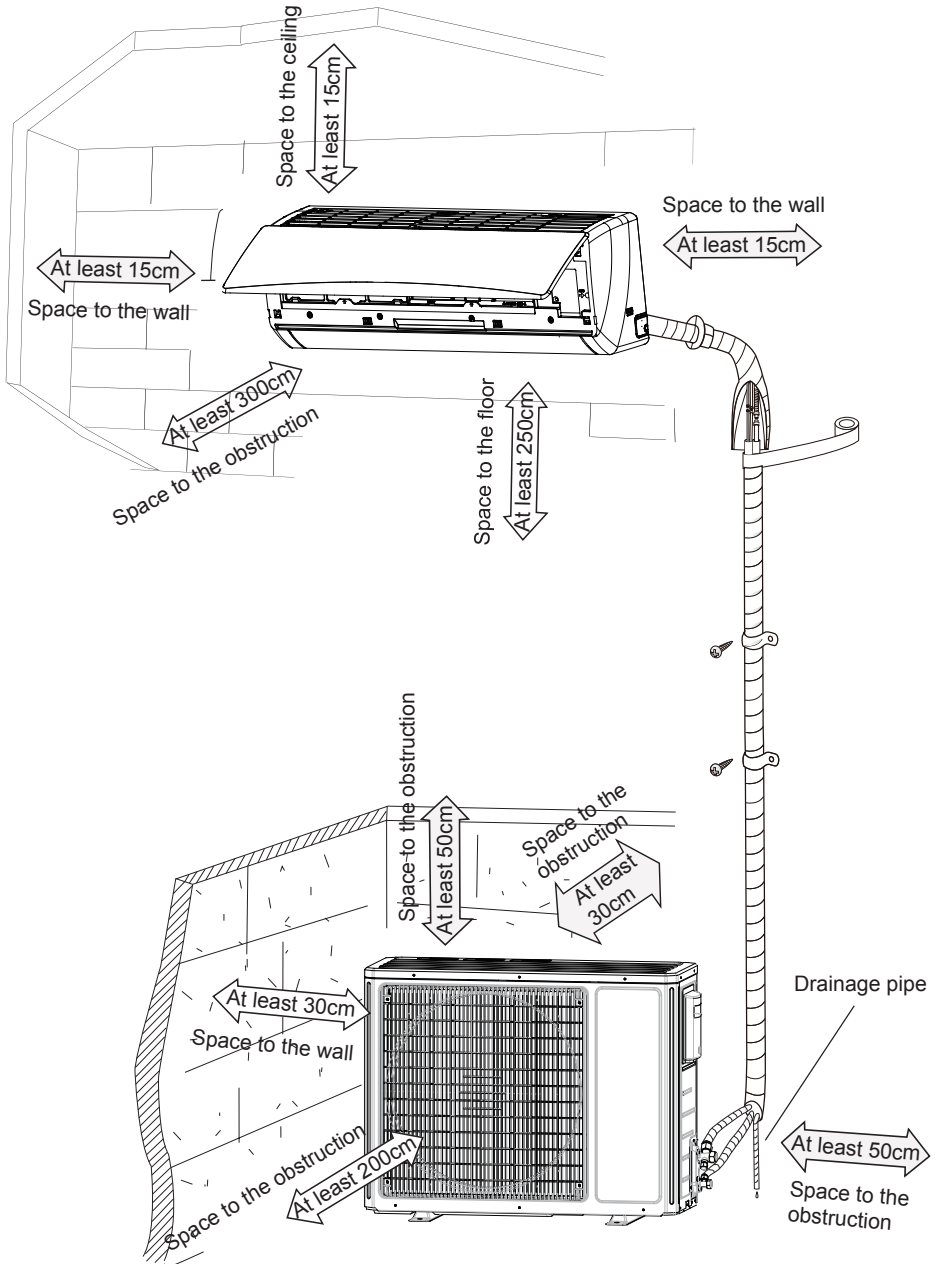

## Tools for installation

1 Level meter	2 Screw driver	3 Impact drill
4 Drill head	5 Pipe expander	6 Torque wrench
7 Open-end wrench	8 Pipe cutter	9 Leakage detector
10 Vacuum pump	11 Pressure meter	12 Universal meter
13 Inner hexagon spanner		14 Measuring tape

### Note:

- Please contact the local agent for installation.
- Don't use unqualified power cord.

## Selection of installation location

### Basic requirement

Installing the unit in the following places may cause malfunction. If it is unavoidable, please consult the local dealer:

1. The place with strong heat sources, vapors, flammable or explosive gas, or volatile objects spread in the air.
2. The place with high-frequency devices (such as welding machine, medical equipment).
3. The place near coast area.
4. The place with oil or fumes in the air.
5. The place with sulfured gas.
6. Other places with special circumstances.
7. The appliance shall not be installed in the laundry.

### Indoor unit

1. There should be no obstruction near air inlet and air outlet.
2. Select a location where the condensation water can be dispersed easily and won't affect other people.
3. Select a location which is convenient to connect the outdoor unit and near the power socket.
4. Select a location which is out of reach for children.
5. The location should be able to withstand the weight of indoor unit and won't increase noise and vibration.
6. The appliance must be installed 2.5m above floor.
7. Don't install the indoor unit right above the electric appliance.
8. Please try your best to keep way from fluorescent lamp.

### Outdoor unit

1. Select a location where the noise and outflow air emitted by the outdoor unit will not affect neighborhood.
2. The location should be well ventilated and dry, in which the outdoor unit won't be exposed directly to sunlight or strong wind.
3. The location should be able to withstand the weight of outdoor unit.
4. Make sure that the installation follows the requirement of installation dimension diagram.
5. Select a location which is out of reach for children and far away from animals or plants. If it is unavoidable, please add the fence for safety purpose.

# Requirements for electric connection

## Safety precaution

1. Must follow the electric safety regulations when installing the unit.
2. According to the local safety regulations, use qualified power supply circuit and air switch.
3. Make sure the power supply matches with the requirement of air conditioner.  
Unstable power supply or incorrect wiring or malfunction. Please install proper power supply cables before using the air conditioner.
4. Properly connect the live wire, neutral wire and grounding wire of power socket.
5. Be sure to cut off the power supply before proceeding any work related to electricity and safety.
6. Do not put through the power before finishing installation.
7. If the supply cord is damaged, it must be replaced by the manufacturer, its service agent or similarly qualified persons in order to avoid a hazard.
8. The temperature of refrigerant circuit will be high, please keep the interconnection cable away from the copper tube.
9. The appliance shall be installed in accordance with national wiring regulations.

## Grounding requirement

1. The air conditioner is the first class electric appliance. It must be properly grounding with specialized grounding device by a professional. Please make sure it is always grounded effectively, otherwise it may cause electric shock.
2. The yellow-green wire in air conditioner is grounding wire, which can't be used for other purposes.
3. The grounding resistance should comply with national electric safety regulations.
4. The appliance must be positioned so that the plug is accessible.
5. An all-pole disconnection switch having a contact separation of at least 3mm in all poles should be connected in fixed wiring.
6. Including an air switch with suitable capacity, please note the following table. Air switch should be included magnet buckle and heating buckle function, it can protect the circuit-short and overload. (Caution: please do not use the fuse only for protect the circuit)

Air-conditioner	Air switch capacity
09、12、18K	16A
24K	25A

# Installation of indoor unit

## Step one: choosing installation location

Recommend the installation location to the client and then confirm it with the client.

---

## Step two: install wall-mounting frame

1. Hang the wall-mounting frame on the wall; adjust it in horizontal position with the level meter and then point out the screw fixing holes on the wall.
  2. Drill the screw fixing holes on the wall with impact drill (the specification of drill head should be the same as the plastic expansion particle) and then fill the plastic expansion particles in the holes.
  3. Fix the wall-mounting frame on the wall with tapping screws (ST4.2X25TA) and then check if the frame is firmly installed by pulling the frame. If the plastic expansion particle is loose, please drill another fixing hole nearby.
- 

## Step three: open piping hole

1. Choose the position of piping hole according to the direction of outlet pipe. The position of piping hole should be a little lower than the wall-mounted frame, shown as below.

09、12K

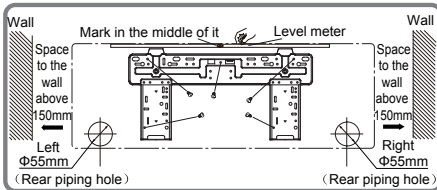

18K

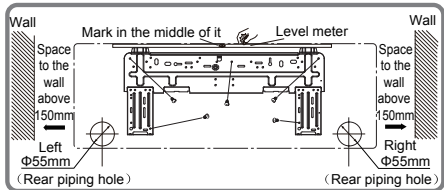

24K

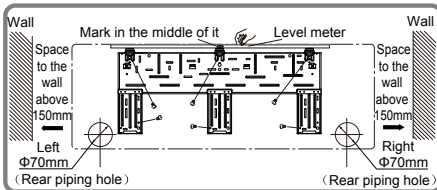

**Note:** Please select the corresponding installation dimensional drawing according to actual wall-mounted plate.

2. Open a piping hole with the diameter of  $\Phi 55/70$  on the selected outlet pipe position. In order to drain smoothly, slant the piping hole on the wall slightly downward to the outdoor side with the gradient of  $5\text{-}10^\circ$ .

# Installation of indoor unit

## Note:

- Pay attention to dust prevention and take relevant safety measures when opening the hole.
- The plastic expansion particles are not provided and should be bought locally.

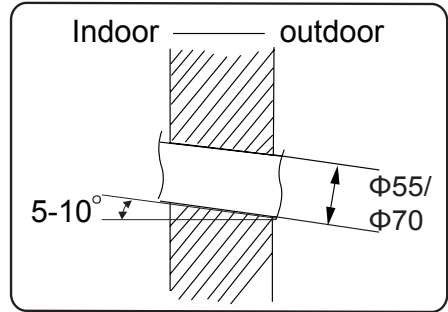

## Step four: outlet pipe

1. The pipe can be led out in the direction of right, rear right, left or rear left.

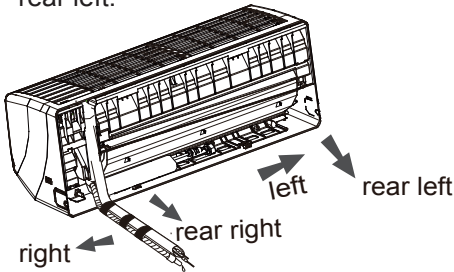

2. When select leading out the pipe from left or right, please cut off the corresponding hole on the bottom case.

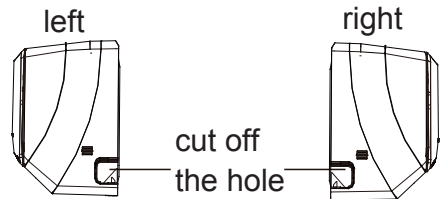

## Step five: connect the pipe of indoor unit

1. Aim the pipe joint at the corresponding bellmouth.
2. Pretightening the union nut with hand.

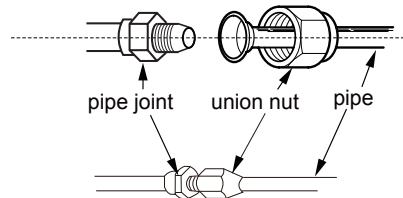

3. Adjust the torque force by referring to the following sheet. Place the open-end wrench on the pipe joint and place the torque wrench on the union nut. Tighten the union nut with torque wrench.

# Installation of indoor unit

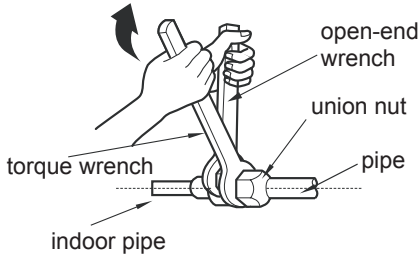

Hex nut diameter	Tightening torque (N·m)
Φ 6	15~20
Φ 9.52	30~40
Φ 12	45~55
Φ 16	60~65
Φ 19	70~75

4. Wrap the indoor pipe and joint of connection pipe with insulating pipe, and then wrap it with tape.

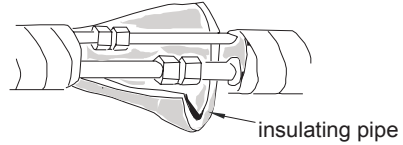

## Step six: install drain hose

1. Connect the drain hose to the outlet pipe of indoor unit.
2. Bind the joint with tape.

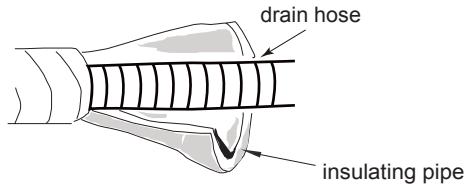
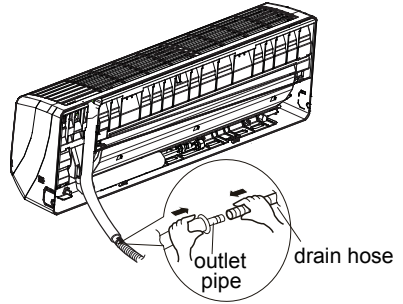
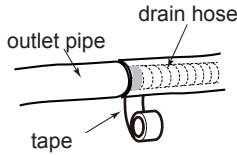

### Note:

- Add insulating pipe in the indoor drain hose in order to prevent condensation.
- The plastic expansion particles are not provided.

## Step seven: connect wire of indoor unit

1. Open the panel, remove the screw on the wiring cover and then take down the cover.

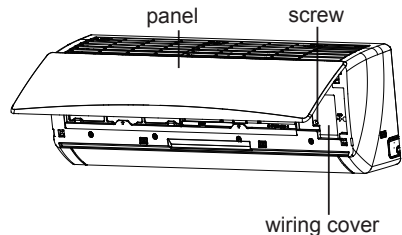



# Installation of indoor unit

2. Make the power connection wire go through the cable-cross hole at the back of indoor unit and then pull it out from the front side.

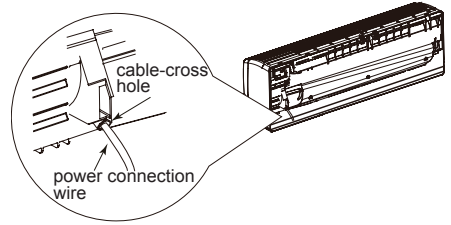

3. Remove the wire clip; connect the power connection wire to the wiring terminal according to the color; tighten the screw and then fix the power connection wire with wire clip.

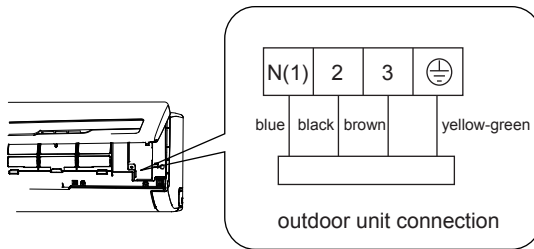

4. Put wiring cover back and then tighten the screw.
5. Close the panel.

## Note:

- All wires of indoor unit and outdoor unit should be connected by a professional.
- If the length of power connection wire is insufficient, please contact the supplier for a new one. Avoid extending the wire by yourself.
- For the air conditioner with plug, the plug should be reachable after finishing installation.
- For the air conditioner without plug, an air switch must be installed in the line. The air switch should be all-pole parting and the contact parting distance should be more than 3mm.

# Installation of indoor unit

## Step eight: bind up pipe

1. Bind up the connection pipe, power cord and drain hose with the band.

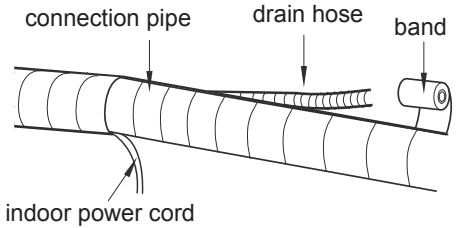
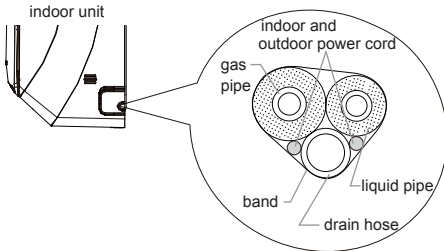

2. Reserve a certain length of drain hose and power cord for installation when binding them. When binding to a certain degree, separate the indoor power and then separate the drain hose.

3. Bind them evenly.
4. The liquid pipe and gas pipe should be bound separately at the end.

### Note:

- The power cord and control wire can't be crossed or winding.
- The drain hose should be bound at the bottom.

## Step nine: hang the indoor unit

1. Put the bound pipes in the wall pipe and then make them pass through the wall hole.
2. Hang the indoor unit on the wall-mounting frame.
3. Stuff the gap between pipes and wall hole with sealing gum.
4. Fix the wall pipe.
5. Check if the indoor unit is installed firmly and closed to the wall.

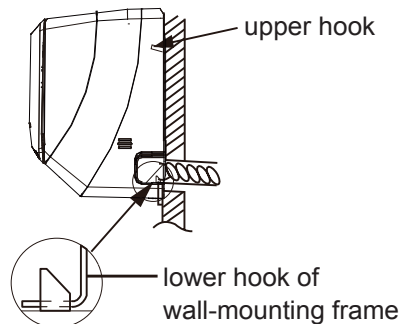
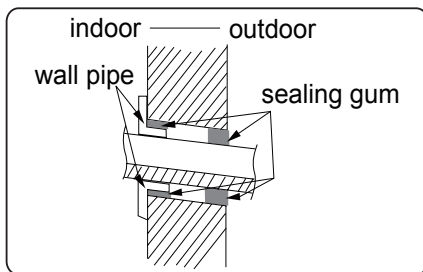

### Note:

- Do not bend the drain hose too excessively in order to prevent blocking.

# Installation of outdoor unit

## Step one: fix the support of outdoor unit

(select it according to the actual installation situation)

1. Select installation location according to the house structure.
2. Fix the support of outdoor unit on the selected location with expansion screws.

### Note:

- Take sufficient protective measures when installing the outdoor unit.
- Make sure the support can withstand at least four times of the unit weight.
- The outdoor unit should be installed at least 3cm above the floor in order to install drain joint.
- For the unit with cooling capacity of 2300W ~5000W, 6 expansion screws are needed;
- for the unit with cooling capacity of 6000W ~8000W, 8 expansion screws are needed;
- for the unit with cooling capacity of 10000W ~16000W, 10 expansion screws are needed.

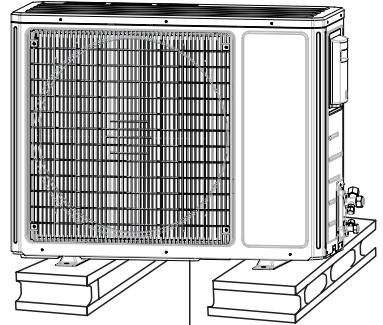

at least 3cm above the floor

## Step two: install drain joint (Only for cooling and heating unit)

1. Connect the outdoor drain joint into the hole on the chassis, as shown in the picture below.
2. Connect the drain hose into the drain vent.

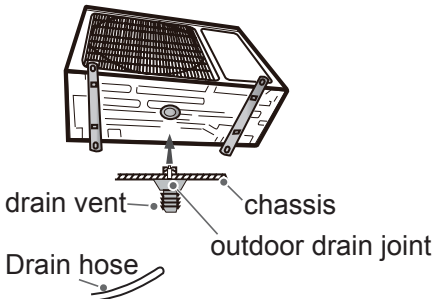

## Step three: fix outdoor unit

1. Place the outdoor unit on the support.
2. Fix the foot holes of outdoor unit with bolts.

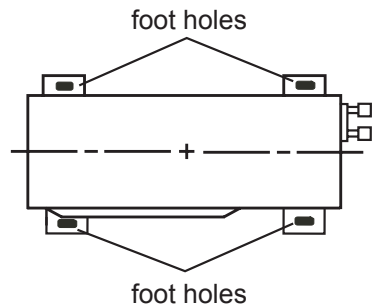

# Installation of outdoor unit

## Step four: connect indoor and outdoor pipes

1. Remove the screw on the right handle of outdoor unit and then remove the handle.

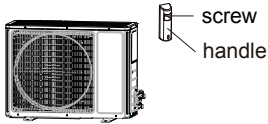

2. Remove the screw cap of valve and aim the pipe joint at the bellmouth of pipe.

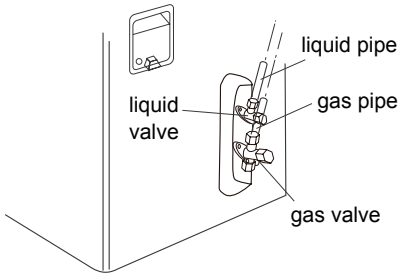

3. Pretightening the union nut with hand.

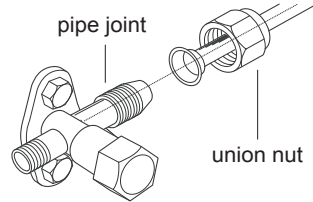

4. Tighten the union nut with torque wrench by referring to the sheet below.

Hex nut diameter	Tightening torque (N·m)
Φ 6	15~20
Φ 9.52	30~40
Φ 12	45~55
Φ 16	60~65
Φ 19	70~75

## Step five: connect outdoor electric wire

1. Remove the wire clip; connect the power connection wire to the wiring terminal according to the color; fix them with screws.

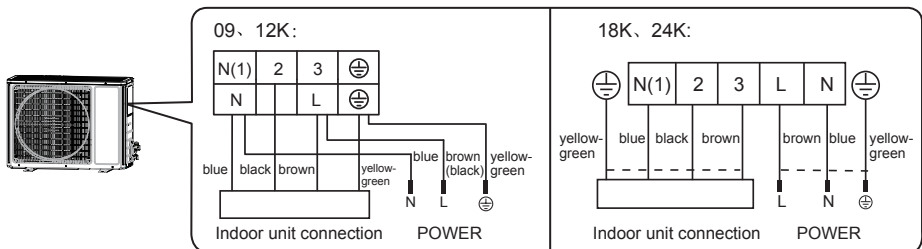

# Installation of outdoor unit

2. Fix the power connection wire and signal control wire with wire clip (only for cooling and heating unit).

## Note:

- After tighten the screw, pull the power cord slightly to check if it is firm.
- Never cut the power connection wire to prolong or shorten the distance.

## Step six: neaten the pipes

1. The pipes should be placed along the wall, bent reasonably and hidden possibly. Min. semidiameter of bending the pipe is 10cm.
2. If the outdoor unit is higher than the wall hole, you must set a U-shaped curve in the pipe before pipe goes into the room, in order to prevent rain from getting into the room.

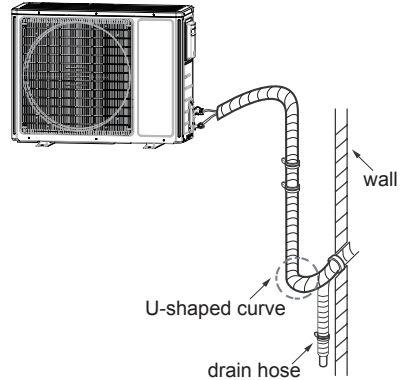

## Note:

- The through-wall height of drain hose shouldn't be higher than the outlet pipe hole of indoor unit.
- Slant the drain hose slightly downwards. The drain hose can't be curved, raised and fluctuant, etc.

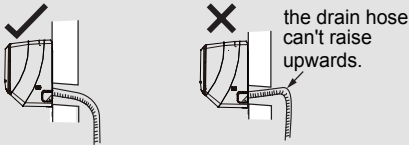

- The water outlet can't be placed in water in order to drain smoothly.

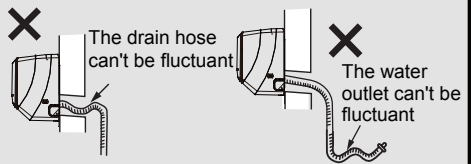
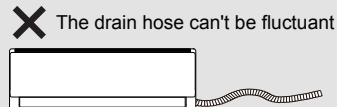
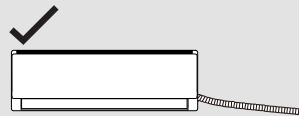
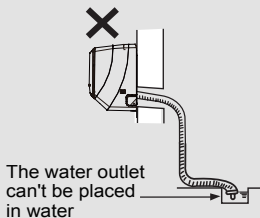

# Vacuum pumping

## Use vacuum pump

1. Remove the valve caps on the liquid valve and gas valve and the nut of refrigerant charging vent.
2. Connect the charging hose of piezometer to the refrigerant charging vent of gas valve and then connect the other charging hose to the vacuum pump.
3. Open the piezometer completely and operate for 10-15min to check if the pressure of piezometer remains in  $-0.1\text{MPa}$ .
4. Close the vacuum pump and maintain this status for 1-2min to check if the pressure of piezometer remains in  $-0.1\text{MPa}$ . If the pressure decreases, there may be leakage.
5. Remove the piezometer, open the valve core of liquid valve and gas valve completely with inner hexagon spanner.
6. Tighten the screw caps of valves and refrigerant charging vent.
7. Reinstall the handle.

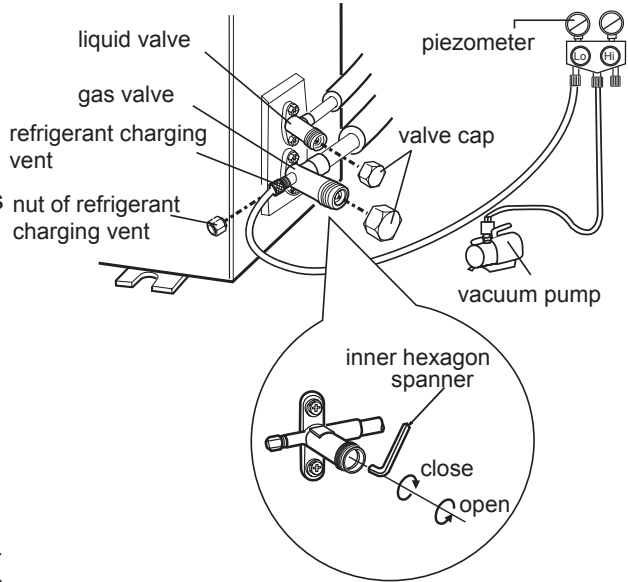

# Leakage detection

1. With leakage detector:  
Check if there is leakage with leakage detector.
2. With soap water:  
If leakage detector is not available, please use soap water for leakage detection. Apply soap water at the suspected position and keep the soap water for more than 3min. If there are air bubbles coming out of this position, there's a leakage.

## Check after installation

- Check according to the following requirement after finishing installation.

Items to be checked	Possible malfunction
Has the unit been installed firmly?	The unit may drop, shake or emit noise.
Have you done the refrigerant leakage test?	It may cause insufficient cooling (heating) capacity.
Is heat insulation of pipeline sufficient?	It may cause condensation and water dripping.
Is water drained well?	It may cause condensation and water dripping.
Is the voltage of power supply according to the voltage marked on the nameplate?	It may cause malfunction or damaging the parts.
Is electric wiring and pipeline installed correctly?	It may cause malfunction or damaging the parts.
Is the unit grounded securely?	It may cause electric leakage.
Does the power cord follow the specification?	It may cause malfunction or damaging the parts.
Is there any obstruction in the air inlet and outlet?	It may cause insufficient cooling (heating) capacity.
The dust and sundries caused during installation are removed?	It may cause malfunction or damaging the parts.
The gas valve and liquid valve of connection pipe are open completely?	It may cause insufficient cooling (heating) capacity.
Is the inlet and outlet of piping hole been covered?	It may cause insufficient cooling (heating) capacity or waster eletricity.

## Test operation

### 1. Preparation of test operation

- The client approves the air conditioner.
- Specify the important notes for air conditioner to the client.

### 2. Method of test operation

- Put through the power, press ON/OFF button on the remote controller to start operation.
- Press MODE button to select AUTO, COOL, DRY, FAN and HEAT to check whether the operation is normal or not.
- If the ambient temperature is lower than 16°C , the air conditioner can't start cooling.

# Configuration of connection pipe

1. Standard length of connection pipe
  - 5m, 7.5m, 8m.
2. Min. length of connection pipe is 3m.
3. Max. length of connection pipe and max. high difference.

Cooling capacity	Max length of connection pipe	Max height difference	Cooling capacity	Max length of connection pipe	Max height difference
5000Btu/h (1465W)	15	5	24000Btu/h (7032W)	25	10
7000Btu/h (2051W)	15	5	28000Btu/h (8204W)	30	10
9000Btu/h (2637W)	15	5	36000Btu/h (10548W)	30	20
12000Btu/h (3516W)	20	10	42000Btu/h (12306W)	30	20
18000Btu/h (5274W)	25	10	48000Btu/h (14064W)	30	20

4. The additional refrigerant oil and refrigerant charging required after prolonging connection pipe
  - After the length of connection pipe is prolonged for 10m at the basis of standard length, you should add 5ml of refrigerant oil for each additional 5m of connection pipe.
  - The calculation method of additional refrigerant charging amount (on the basis of liquid pipe):
 

Additional refrigerant charging amount = prolonged length of liquid pipe × additional refrigerant charging amount per meter
  - Basing on the length of standard pipe, add refrigerant according to the requirement as shown in the table. The additional refrigerant charging amount per meter is different according to the diameter of liquid pipe. See the following sheet.



# Configuration of connection pipe

Additional refrigerant charging amount for R22, R407C, R410A and R134a

Diameter of connection pipe		Outdoor unit throttle	
Liquid pipe(mm)	Gas pipe(mm)	Cooling only(g/m)	Cooling and heating(g/m)
Φ6	Φ9.52 or Φ12	15	20
Φ6 or Φ9.52	Φ16 or Φ19	15	50
Φ12	Φ19 or Φ22.2	30	120
Φ16	Φ25.4 or Φ31.8	60	120
Φ19	—	250	250
Φ22.2	—	350	350

# Pipe expanding method

## Note:

Improper pipe expanding is the main cause of refrigerant leakage. Please expand the pipe according to the following steps:

### A: Cut the pipe

- Confirm the pipe length according to the distance of indoor unit and outdoor unit.
- Cut the required pipe with pipe cutter.

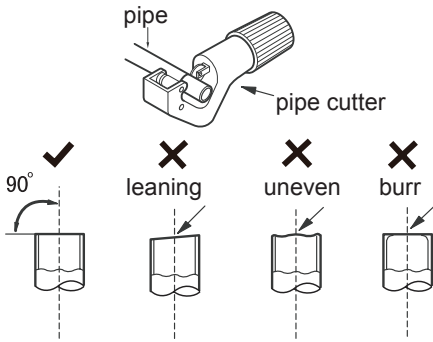

### B: Remove the burrs

- Remove the burrs with shaper and prevent the burrs from getting into the pipe.

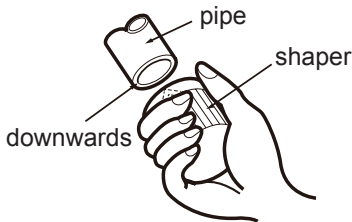

### C: Put on suitable insulating pipe

### D: Put on the union nut

- Remove the union nut on the indoor connection pipe and outdoor valve; install the union nut on the pipe.

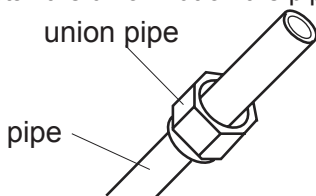

### E: Expand the port

- Expand the port with expander.

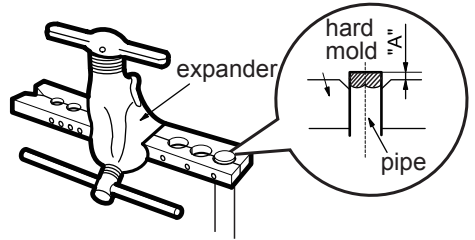

### Note:

- "A" is different according to the diameter, please refer to the sheet below:

Outer diameter (mm)	A(mm)	
	Max	Min
Φ6 - 6.35(1/4")	1.3	0.7
Φ9.52(3/8")	1.6	1.0
Φ12-12.7(1/2")	1.8	1.0
Φ15.8-16(5/8")	2.4	2.2

### F: Inspection

- Check the quality of expanding port. If there is any blemish, expand the port again according to the steps above.

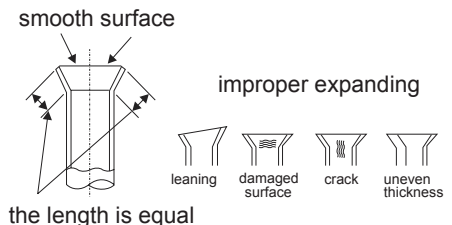

# Wired Controller (Optional)

If the product you bought is equipped with wired controller, please refer to the following introductions of wired controller.

## 1 Displaying Part

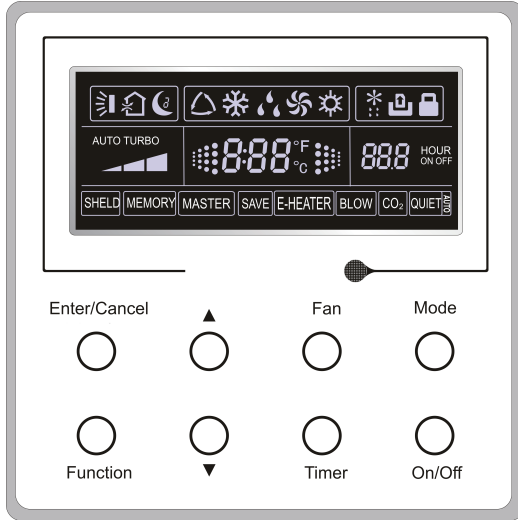

Fig1.1.1 Outline of wired controller

## 1.1 LCD Display of Wired Controller

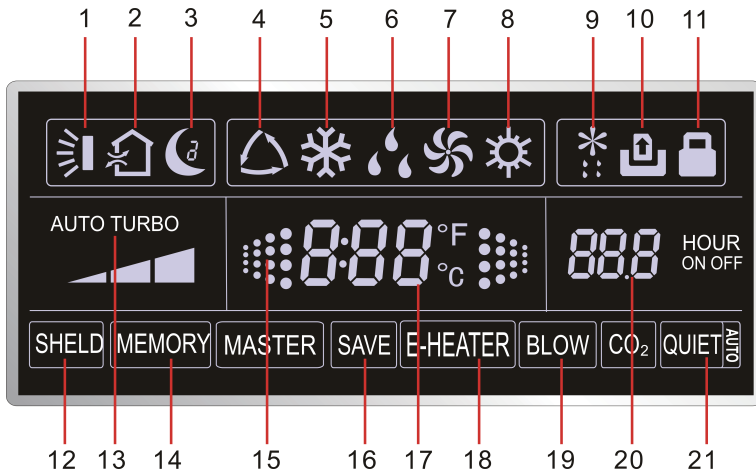















Fig.1.1.2 LCD display

# Wired Controller (Optional)

## 1.2 Instruction to LCD Display

Table 1.1

No.	Symbols	Description
1		Swing function
2		Air exchange function (this function is yet unavailable for this unit).
3		Sleep function (Only sleep 1).
4		Each kind of running mode of indoor unit (auto mode)
5		Cooling mode
6		Dry mode
7		Fan mode
8		Heating mode
9		Defrosting function for the outdoor unit.
10		Gate-control function (this function is yet unavailable for this unit).
11		Lock function.
12	SHIELD	Shield functions (Button operation, temperature setting, On/Off operation, Mode setting are disabled by the remote monitoring system.)
13	Turbo	Turbo function state
14	MEMORY	Memory function (The indoor unit resumes the original setting state after power failure and then power recovery).
15		It blinks under on state of the unit without operation of any button.
16	SAVE	Energy-saving function (this function is yet unavailable for this unit).
17		Ambient/setting temperature value
18	E-HEATER	Electric auxiliary heating function.
19	BLOW	Blow function.
20		Timing value.
21	QUIET	Quiet function (two types: quiet and auto quiet) (this function is yet unavailable for this unit).

# Wired Controller (Optional)

## 2 Buttons

### 2.1 Layout of Buttons

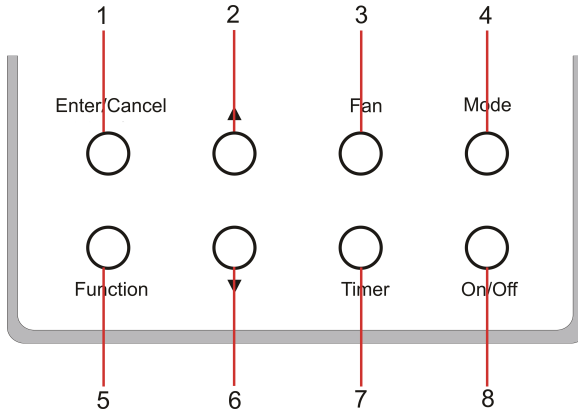

### 2.2 Functions of Buttons

Table 2.1

No.	Name	Function
1	Enter/Cancel	Function selection and cancellation.
2	▲	① . Running temperature setting of the indoor unit, range:16~30°C. ② . Timer setting, range:0.5-24 hr.
6	▼	
3	Fan	Setting of the high/middle/low/auto fan speed.
4	Mode	Setting of the Cooling/Heating/Fan/Dry/Auto mode of the indoor unit.
5	Function	Switchover among the functions of Turbo/Save/E-heater/Blow etc..
7	Timer	Timer setting.
8	On/Off	Turn on/off the indoor unit
4+2	▲+Mode	Press them for 5s under off state of the unit to enter/cancel the Memory function.(If memory is set, indoor unit after power failure and then power recovery will resume the original setting state. If not, the indoor unit is defaulted to be off after power recovery. Memory off is default before delivery.).
3+6	Fan+▼	By pressing them at the same time under off state of the unit, ❄️ will be displayed on the wired controller for the cooling only unit, while ❄️🔥 will be displayed on the wired controller for the cooling and heating unit.
2+6	▲+▼	Upon startup of the unit without malfunction or under off state of the unit,press them at the same time for 5s to enter the lock state, in which case,any other buttons won't respond the press. Repress them for 5s to quit this state.

# Wired Controller (Optional)

## 3 Operation Instructions

### 3.1 On/Off

Press On/Off to turn on the unit and turn it off by another press.

Note: The state shown in Fig.3.1.1 indicates the “Off” state of the unit after power on. The state shown in Fig.3.1.2 indicates the “On” state of the unit after power on.

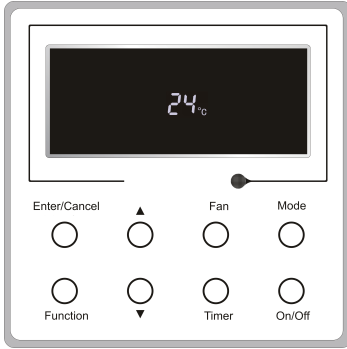

Fig.3.1.1 “Off” State

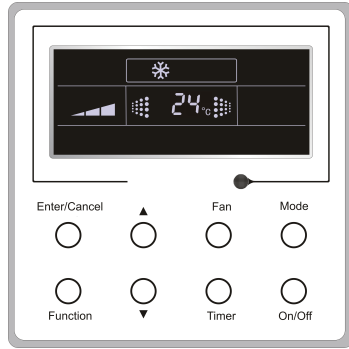
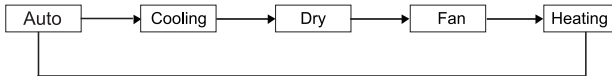

Fig.3.1.2 “On” State

### 3.2 Mode Setting

Under ON state of the unit, press the Mode to switch the operation modes as the following sequence: Auto–Cooling–Dry–Fan–Heating.



### 3.3 Temperature Setting

Press ▲ or ▼ to increase/decrease the preset temperature. If pressing either of them continuously, the temperature will be increased or decreased by 1°C every 0.5s, as shown in Fig.3.3.1.

In the Cooling, Dry, Fan or Heating mode, the temperature setting range is 16°C~30°C.

In the Auto mode, the setting temperature is unadjustable.

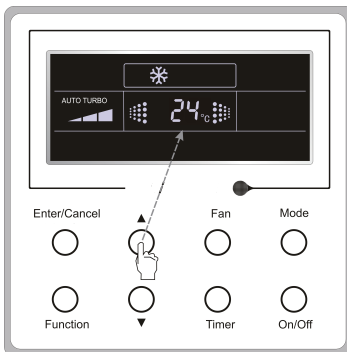

Fig.3.3.1

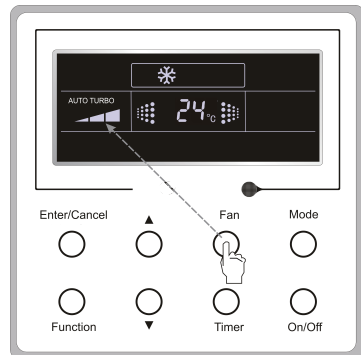
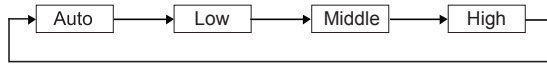

Fig.3.4.1

# Wired Controller (Optional)

## 3.4 Fan Setting

Under the “On” state of the unit, press Fan and then fan speed of the indoor unit will change circularly as shown in Fig.3.4.1.



## 3.5 Timer Setting

Under on-state of the unit, Press Timer button to set timer off of the unit. Under off-state of the unit, press Timer button to set timer on of the unit in the same way.

### • Timer on setting:

Under off-state of the unit without timer setting, if Timer button is pressed, LCD will display xx. Hour, with ON blinking. In this case, press ▲ or ▼ button to adjust timer on and then press Timer to confirm.

### • Timer off setting:

Under on-state of the unit without timer setting, if Timer button is pressed, LCD will display xx. Hour, with OFF blinking. In this case, press ▲ or ▼ button to adjust timer on and then press Timer to confirm.

### • Cancel timer:

After setting of timer, if Timer button is pressed, LCD won't display xx. Hour so that timer setting is canceled.

Timer off setting under the “On” state of the unit is shown as Fig.3.5.1.

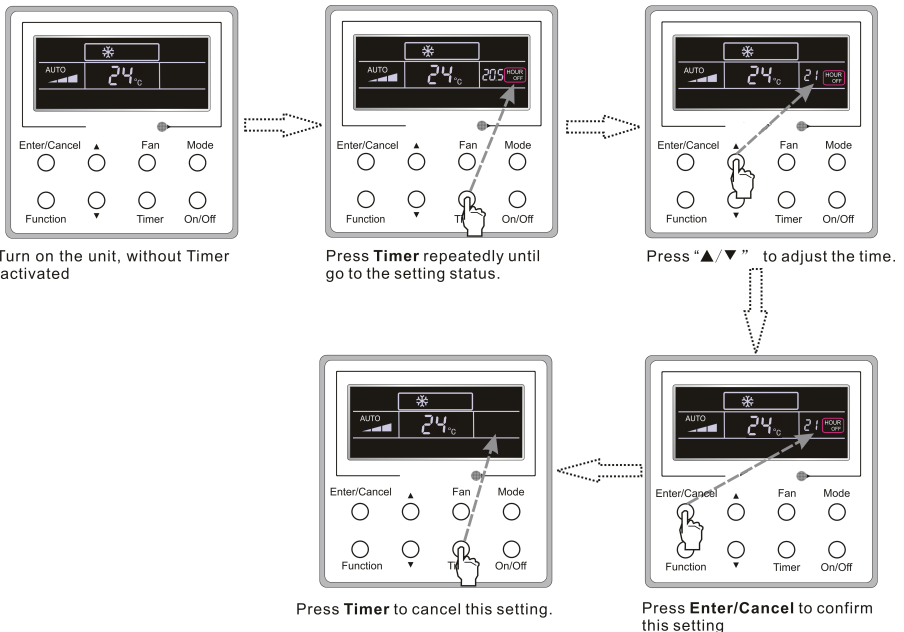
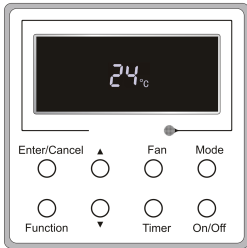

Fig.3.5.1 Timer off Setting under the “On” State of the Unit

# Wired Controller (Optional)

Timer on setting under the "Off" state of the unit is shown as Fig.3.5.2.



Turn off the unit, without Timer activated

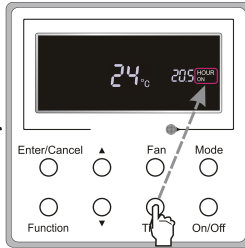

Press **Timer** repeatedly until go to the setting status.

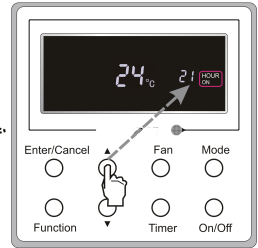

Press "**▲/▼**" to adjust the time.

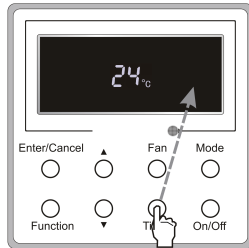

Press **Timer** to cancel this setting.

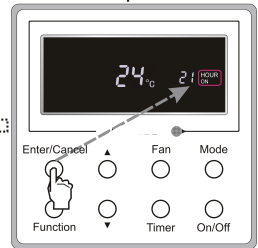

Press **Enter/Cancel** to confirm this setting

Fig.3.5.2 Timer on Setting under the "Off" State of the Unit

Timer range: 0.5-24hr. Every press of **▲** or **▼** will make the set time increased or decreased by 0.5hr. If either of them is pressed continuously, the set time will increase/ decrease by 0.5hr every 0.5s.



# Wired Controller (Optional)

## 3.6 Swing Setting

**Swing On:** Press **Function** under on state of the unit to activate the swing function. In this case,  will blink. After that, press **Enter/Cancel** to make a confirmation.

**Swing Off:** When the Swing function is on, press **Function** to enter the Swing setting interface, with  blinking. After that, press **Enter/Cancel** to cancel this function. Swing setting is shown as Fig.3.6.1.

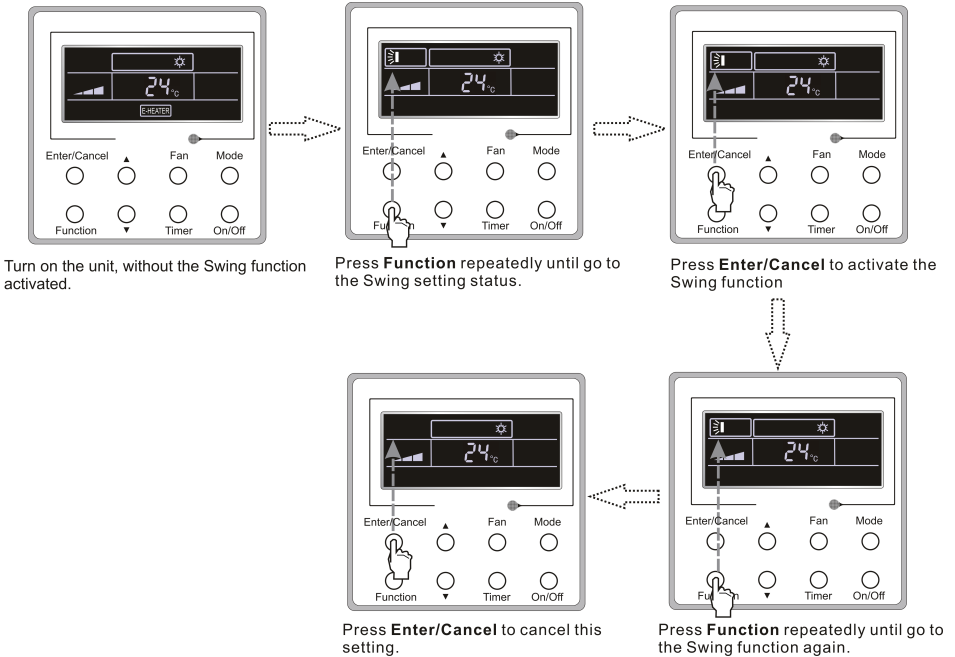

Fig.3.6.1 Swing Setting

### Notes:

- ① . Sleep, Turbo or Blow setting is the same as the Swing setting.
- ② . After the setting has been done, it has to press the key "Enter/Cancel" to back to the setting status or quit automatically five seconds later.

# Wired Controller (Optional)

## 3.7 Sleep Setting

Sleep on: Press Function under the On state of the unit till the unit enters the Sleep setting state. After that, press Enter/Cancel to confirm this setting.

Sleep off: When the Sleep function is activated, press Function to enter the Sleep setting status. After that, press Enter/Cancel to cancel this function.

In the Cooling or Dry mode, the temperature will increase by 1°C after the unit runs under Sleep1 for 1hr and 1°C after another 1hr. After that, the unit will run at this temperature.

In the Heating mode, the temperature will decrease by 1°C after the unit runs under Sleep 1 for 1hr and 1°C after another 1hr. After that, the unit will run at this temperature.

Sleep setting is shown as Fig.3.7.1.

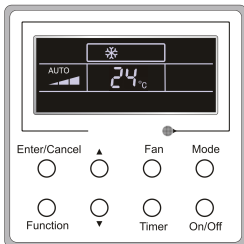

Turn on the unit, without the Sleep function activated.

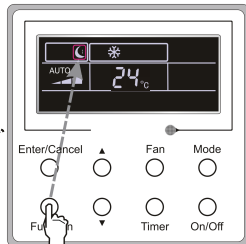

Press **Function** repeatedly until go to the Sleep setting status.

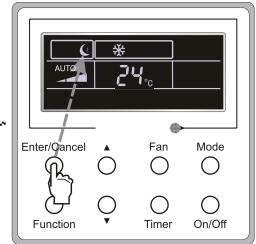

Press **Enter/Cancel** to activate the Sleep function.

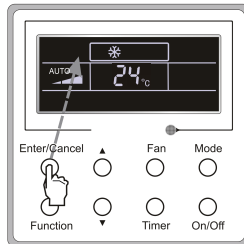

Press **Enter/Cancel** to cancel this setting.

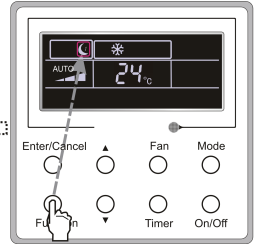

Press **Function** repeatedly until go the Sleep setting status again.

Fig.3.7.1. Sleep Setting

# Wired Controller (Optional)

## 3.8 Turbo Setting

Turbo function: The unit at the high fan speed can realize quick cooling or heating so that the room temperature can quickly approach the setting value.

In the Cooling or Heating mode, press **Function** till the unit enters the Turbo setting status and then press **Enter/Cancel** to confirm the setting.

When the Turbo function is activated, press **Function** to enter the Turbo setting status and then press **Enter/Cancel** to cancel this function.

Turbo function setting is as shown in Fig.3.8.1.

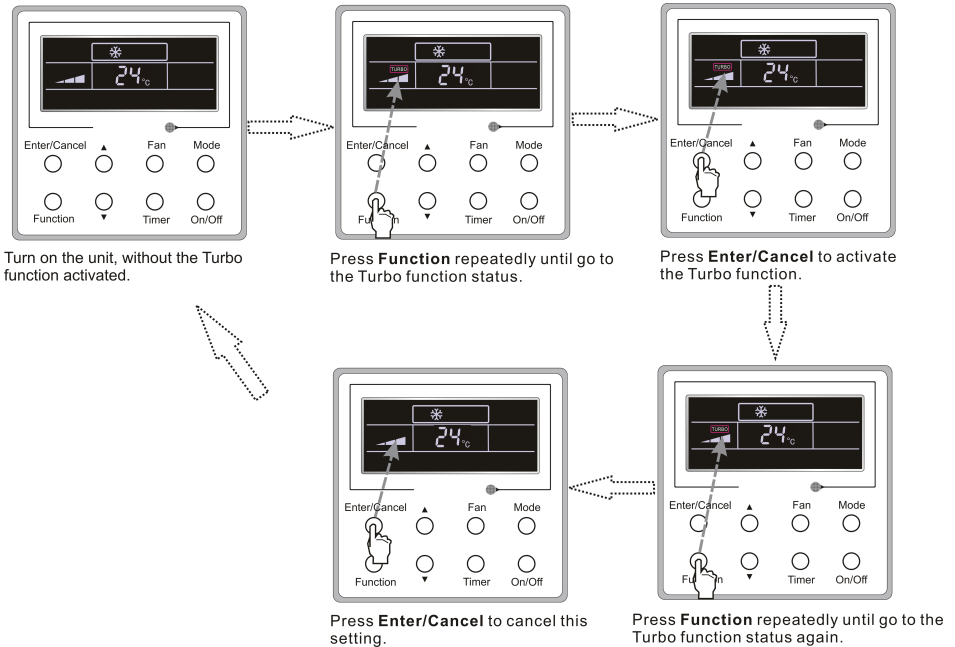

Fig.3.8.1 Turbo Setting

# Wired Controller (Optional)

## 3.9 E-heater Setting

E-heater (auxiliary electric heating function): In the Heating mode, E-heater is allowed to be turned on for improvement of efficiency.

Once the wired controller or the remote controller enters the Heating mode, this function will be turned on automatically.

Press **Function** in the Heating mode to enter the E-heater setting interface and then press **Enter/Cancel** to cancel this function.

Press **Function** to enter the E-heater setting status, if the E-heater function is not activated, and then press **Enter/Cancel** to activate it.

The setting of this function is shown as Fig.3.9.1 below:

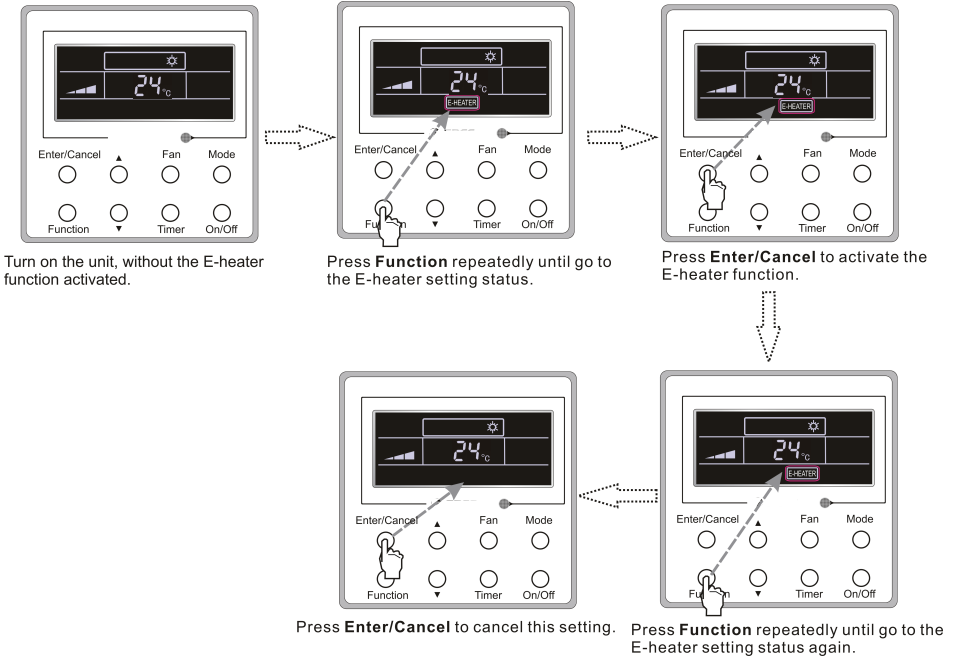

Fig.3.9.1 E-heater Setting

# Wired Controller (Optional)

## 3.10 Blow Setting

Blow function: After the unit is turned off, the water in evaporator of indoor unit will be automatically evaporated to avoid mildew.

In the Cooling or Dry mode, press **Function** till the unit enters the Blow setting status and then press **Enter/Cancel** to activate this function.

When the Blow function is activated, press **Function** to the Blow setting status and then press **Enter/Cancel** to cancel this function.

Blow function setting is as shown in Fig.3.10.1

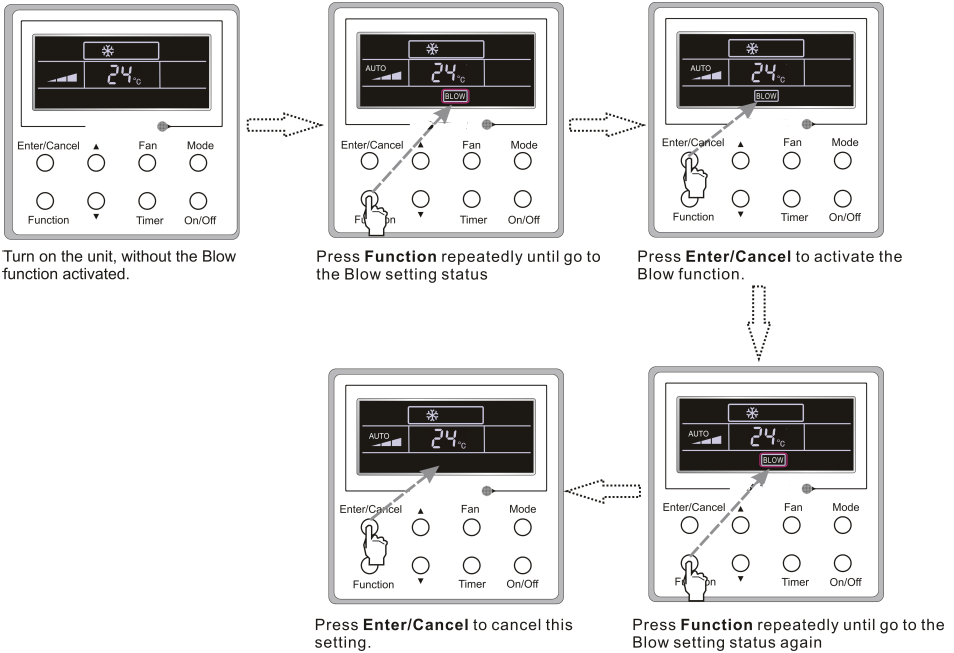

Fig.3.10.1 Blow Setting

### Notes:

- ① . When the Blow function is activated, if turning off the unit by pressing **On/Off** or by the remote controller, the indoor fan will run at the low fan speed for 2 min, with “BLOW” displayed on the LCD. While, if the Blow function is deactivated, the indoor fan will be turned off directly.
- ② . Blow function is unavailable in the Fan or Heating mode.

# Wired Controller (Optional)

## 3.11 Other Functions

### a. Lock

Upon startup of the unit without malfunction or under the "Off" state of the unit, press ▲ and ▼ at the same time for 5s till the wired controller enters the Lock function. In this case, LCD displays .

After that, repress these two buttons at the same time for 5s to quit this function.

Under the Lock state, any other button press won't get any response.

### b. Memory

Memory switchover: Under the "Off" state of the unit, press Mode and ▲ at the same time for 5s to switch memory states between memory on and memory off. When this function is activated, Memory will be displayed. If this function is not set, the unit will be under the "Off" state after power failure and then power recovery.

Memory recovery: If this function has been set for the wired controller, the wired controller after power failure will resume its original running state upon power recovery. Memory contents: On/Off, Mode, set temperature, set fan speed and Lock function.

## 4 Installation and Dismantlement

### 4.1 Connection of the Signal Line of the Wired Controller

- Open the cover of the electric control box of the indoor unit.
- Let the single line of the wired controller through the rubber ring.
- Connect the signal line of the wired control to the 4-pin socket of the indoor unit PCB.
- Tighten the signal wire with ties.
- The communication distance between the main board and the wired controller can be up to 20 meters ( the standard distance is 8 meters)

### 4.2 Installation of the Wired Controller

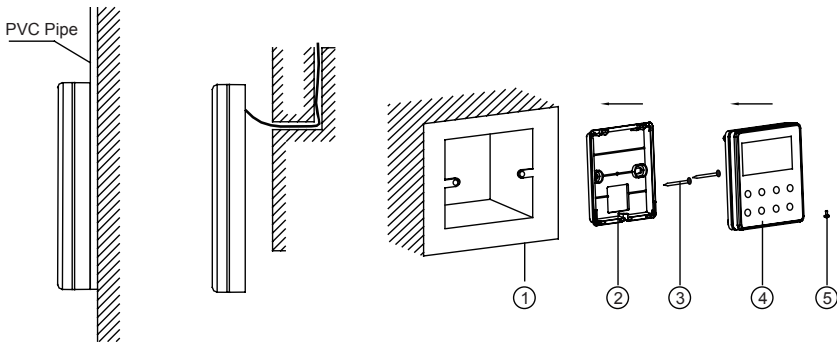

Fig.4.1 Accessories for the Installation of the Wired Controller

Table 4.1

No.	1	2	3	4	5
Name	Socket box embedded in the wall	Soleplate of the Wired Controller	Screw M4X25	Front Panel of the Wired Controller	Screw ST 2.9X6

# Wired Controller (Optional)

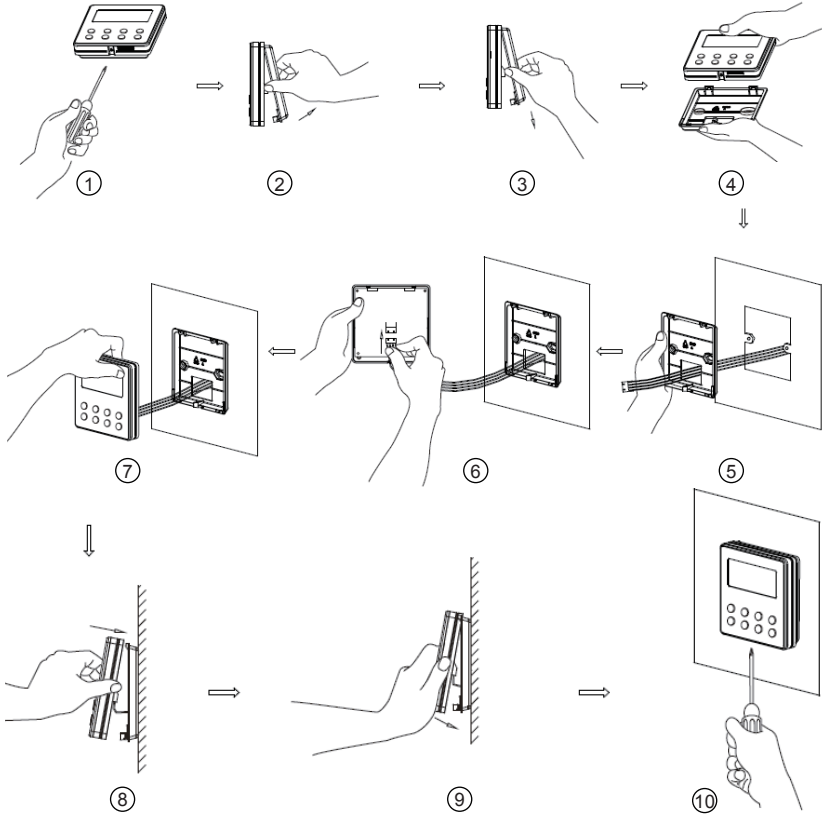

Fig.4.2

Fig.4.2 shows the installation steps of the wired controller, but there are some issues that need your attention.

1) Prior to the installation, please firstly cut off the power supply of the wire buried in the installation hole, that is, no operation is allowed with electricity during the whole installation.

2) Pull out the four-core twisted pair line from the installation holes and then let it go through the rectangular hole behind the soleplate of the wired controller.

3) Stick the soleplate of the wired controller to the wall over the installation hole and then fix it with screws M4X25.

4) Insert the four-core twisted pair line into the slot of the wired controller and then buckle the front panel and the soleplate of the wired controller together.

5) Finally, fix the front panel and the soleplate of the wired controller tightly by screws ST2.9X6.

## CAUTION!

Please pay special attention to the followings during the connection to avoid the malfunction of the air conditioning unit due to electromagnetic interference.

① . Separate the signal and communication lines of the wired controller from the power cord

# Wired Controller (Optional)

and connection lines between the indoor and outdoor unit, with a minimum interval of 20cm, otherwise the communication of the unit will probably work abnormally.

②. If the air conditioning unit is installed where is vulnerable to electromagnetic interference, then the signal and communication lines of the wired controller must be the shielding twisted pair lines.

## 4.3 Dismantlement of the Wired Controller

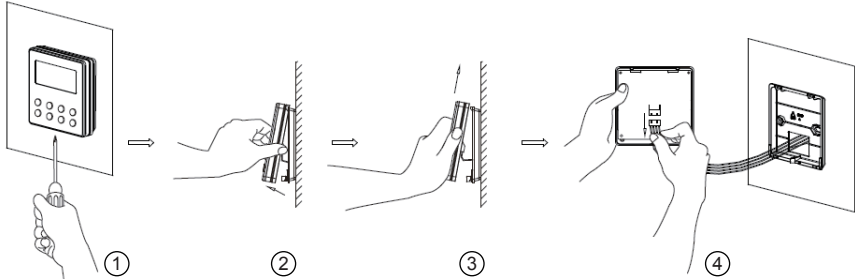

## 5 Errors Display

If there is an error occurring during the operation of the system, the error code will be displayed on the LCD, as show in Fig.5.1. If multi errors occur at the same time, their codes will be displayed circularly.

Note: In event of any error, please turn off the unit and contact the professionally skilled personnel.

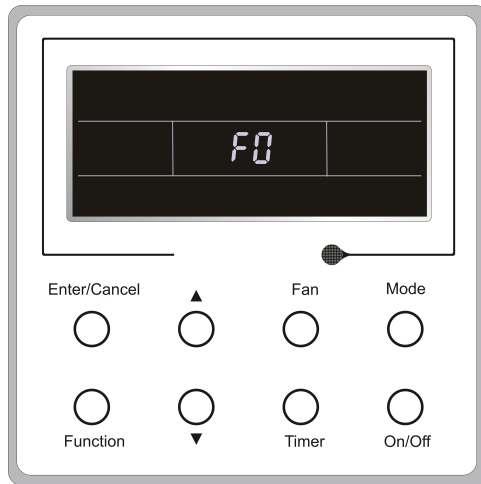

Fig.5.1



# Wired Controller (Optional)

Table 5.1 Meaning of Each Error

Error	Error Code	Error	Error Code
Return air temperature sensor open/ short circuited	F1	Drive board communication error	P6
evaporator temperature sensor open/ short circuited	F2	Compressor overheating protection	H3
Indoor unit liquid valve temperature sensor open/short circuited	b5	Indoor and outdoor units unmatched	LP
Indoor gas valve temperature sensor open/ short circuited	b7	Communication line misconnected or expansion valve error	dn
IPM temperature sensor open/short circuited	P7	Running mode conflict	E7
Outdoor ambient temperature sensor open/ short circuited	F3	Pump-down	Fo
Outdoor unit condenser mid-tube temperature sensor open/short circuited	F4	Jumper error	C5
Discharge temperature sensor open/ short circuited	F5	Forced defrosting	H1
Indoor and outdoor communication error	E6	Compressor startup failure	Lc
DC bus under-voltage protection	PL	High discharge temperature protection	E4
DC bus over-voltage protection	PH	Overload protection	E8
Compressor phase current sensing circuit error	U1	Whole unit over-current protection	E5
Compressor demagnetization protection	HE	Over phase current protection	P5
PFC protection	Hc	Compressor desynchronizing	H7
IPM Temperature Protection	P8	IPM Current protection	H5
Over-power protection	L9	Compressor phase loss/reversal protection	Ld
System charge shortage or blockage protection	F0	Frequency restricted/reduced with whole unit current protection	F8
Capacitor charging error	PU	Frequency restricted/reduced with IPM current protection	En
High pressure protection	E1	Frequency restricted/reduced with high discharge temperature	F9
Low pressure protection	E3	Frequency restricted/reduced with anti-freezing protection	FH
Compressor stalling	LE	Frequency restricted/reduced with overload protection	F6
Over-speeding	LF	Frequency restricted/reduced with IPM temperature protection	EU
Drive board temperature sensor error	PF	Indoor unit full water error	E9
AC contactor protection	P9	Anti-freezing protection	E2
Temperature drift protection	PE	AC input voltage abnormal	PP
Sensor connection protection	Pd	Whole unit current sensing circuit error	U5
DC bus voltage drop error	U3	4-way valve reversing error	U7
Outdoor fan 1 error protection	L3	Motor stalling	H6
Outdoor fan 2 error protection	LA	PG motor zero-crossing protection	U8

**Designed by Cooper&Hunter International Corporation, Oregon, USA**  
**[www.cooperandhunter.com](http://www.cooperandhunter.com)**

\* Cooper & Hunter is constantly working to improve their products, so the information in this manual is subject to change without prior notice.



66160000324